



ZOLL Ventilator Operator's Guide

Models: EMV+, AEV, Eagle II



The issue date for the *ZOLL Ventilator Operator's Guide* (REF 906-0731-01-05 Rev. B) is **May, 2017**.

Copyright © 2017 ZOLL Medical Corporation. All rights reserved. ZOLL, AEV, and EMV+ are registered trademarks of ZOLL Medical Corporation in the United States and/or other countries. Eagle II and Smart Help are trademarks of ZOLL Medical Corporation in the United States and/or other countries. All other trademarks are the property of their respective owners.

Masimo Pulse Oximeter

This device uses Masimo SET® technology to provide continuous pulse oximeter and heart rate monitoring and is covered under one or more of the following U.S.A. patents: 5,758,644, 5,823,950, 6,011,986, 6,157,850, 6,263,222, 6,501,975 and other applicable patents listed at www.masimo.com/patents.htm.



Limited Copyright Release

Permission is hereby granted to any military/governmental agency to reproduce all materials furnished herein for use in a military/governmental service training program and/or other technical training program.



ZOLL Medical Corporation
269 Mill Road
Chelmsford, MA USA
01824-4105



ZOLL International Holding B.V.
Newtonweg 18
6662 PV ELST
The Netherlands



0123

Chapter 1 **General Information**

PRODUCT DESCRIPTION	1-1
HOW TO USE THIS MANUAL	1-1
OPERATOR'S GUIDE UPDATES	1-2
UNPACKING	1-2
ASSEMBLY	1-2
SYMBOLS ON THE VENTILATOR1-	1-2
SYMBOLS ON THE VENTILATOR'S GRAPHICAL USER INTERFACE (GUI).....	1-5
CONVENTIONS	1-7
ABBREVIATIONS	1-8
ZOLL VENTILATOR INDICATIONS FOR USE.....	1-9
WARNINGS.....	1-11
FDA TRACKING REQUIREMENTS	1-16
SOFTWARE LICENSE.....	1-17
SERVICE.....	1-19

Chapter 2 **Product Overview**

ZOLL VENTILATOR MODELS	2-2
ZOLL VENTILATOR FEATURES	2-3
ZOLL VENTILATOR DEVICE DESCRIPTION	2-4
CONTROLS AND INDICATORS.....	2-6
DISPLAY SCREEN	2-7
PNEUMATIC DESIGN	2-9
FRESH GAS INTAKE AND ATTACHMENTS	2-10
TOP PANEL	2-10
VENTILATOR CIRCUITS.....	2-12
PULSE OXIMETER SENSORS.....	2-14
POWER SOURCES.....	2-14

Chapter 3 Setting Up the ZOLL Ventilator

1. ATTACH THE VENTILATOR CIRCUIT	3-2
2. ATTACH THE HIGH PRESSURE OXYGEN SUPPLY (OPTIONAL)	3-3
3. INSPECT FRESH GAS INTAKE FILTERS	3-3
4. CONNECT FRESH GAS INTAKE ATTACHMENTS.....	3-4
5 SELECT THE VENTILATOR'S POWER SOURCE	3-5
6. POWER ON THE VENTILATOR.....	3-7
7. SELECT START UP DEFAULT VALUES	3-8
8. SELECT OPERATING MODE (OPTIONAL)	3-10
9. CHANGE PARAMETER VALUES	3-11
10. CHANGE VENTILATOR SETTINGS	3-11
11. PERFORM OPERATIONAL TEST	3-12
12. ATTACH THE PULSE OXIMETER PROBE (OPTIONAL)	3-13
13. ATTACH PATIENT	3-13

Chapter 4 Using the ZOLL Ventilator

THE VENTILATOR INTERFACE	4-2
PARAMETER BUTTONS.....	4-3
MODE.....	4-3
BPM (BREATHES PER MINUTE) -- TIMING AND RATE MANAGEMENT	4-5
Vt (TIDAL VOLUME)	4-8
PIP (PEAK INSPIRATORY PRESSURE) -- LUNG PRESSURE MANAGEMENT.....	4-9
FIO2 (FRACTION OF INSPIRED OXYGEN) -- OXYGEN DELIVERY MANAGEMENT.....	4-11
SPO2 -- USING THE PULSE OXIMETER.....	4-12
HR (HEART RATE)	4-15
MANAGING POP UP MESSAGES	4-16
MANAGING ALARMS.....	4-17
SILENCING ALARMS.....	4-21

Chapter 5 Alarms

ALARM OVERVIEW	5-2
ALARM PRIORITIES.....	5-4
MUTING ALARMS.....	5-5
ALARMS TYPES.....	5-5
ALARM GROUPS	5-6
HIGH PRIORITY ALARMS	5-8
MEDIUM PRIORITY ALARMS.....	5-12
LOW PRIORITY ALARMS.....	5-18
POP UP MESSAGES	5-26

Chapter 6 Operating Environments

USING THE ZOLL VENTILATOR IN HARSH ENVIRONMENTS	6-1
USING THE ZOLL VENTILATOR IN HAZARDOUS ENVIRONMENTS	6-4
USING THE ZOLL VENTILATOR IN AN MRI ENVIRONMENT	6-7

Chapter 7 Maintenance

INSPECTING THE ZOLL VENTILATOR	7-1
CLEANING.....	7-2
GAS INTAKE FILTERS.....	7-3
REPLACING THE ZOLL VENTILATOR'S FILTERS	7-4
BATTERY MAINTENANCE.....	7-5
CALIBRATION CHECKS.....	7-8
TROUBLESHOOTING.....	7-9

Appendix A Specifications

GENERAL.....	A-1
PULSE OXIMETER	A-3
DEVICE CLASSIFICATION.....	A-4

Appendix B Accessories

Appendix C Pulse Oximeter Principles

Appendix D Patient Circuits

PEDIATRIC/ADULT, SINGLE-LIMB, WYE PATIENT CIRCUITSD-2

INFANT/PEDIATRIC, SINGLE-LIMB, WYE PATIENT CIRCUITSD-8

Chapter 1

General Information

This chapter provides general information about the ZOLL ventilator and the *ZOLL Ventilator Operator's Guide*, which we provide with this product. Specifically, this chapter provides

- A brief description of the ZOLL Ventilator.
- Information about this manual (*ZOLL Ventilator Operator's Guide*).
- A table that describes the symbols that appear on the ventilator and in this manual.
- The ZOLL Ventilator's **Indications for Use**.
- A list of **Warnings** and **Cautions** regarding the use of the ventilator.
- Information regarding FDA tracking requirements, and the product's warranty and software license.
- How to contact ZOLL Medical Corporation for service to this product.

Product Description

The ZOLL Ventilator is a small, extremely durable, full-featured portable mechanical ventilator designed to operate in hospitals or severe and under-resourced environments. It can be used in prehospital, field hospital and hospital settings.

How to Use this Manual

The *ZOLL Ventilator Operator's Guide* provides information that operators need for the safe and effective use and care of the ventilator. It is important that all persons using this device read and understand all the information contained within.

Please thoroughly read the warnings section.

Procedures for unit care are located in Chapter 7, "Maintenance".

Operator's Guide Updates

An issue or revision date for this manual is shown on the front cover. If more than 3 years have elapsed since this date, contact ZOLL Medical Corporation to determine if additional product information updates are available.

All users should carefully review each manual update to understand its significance and then file it in its appropriate section within this manual for subsequent reference.

Product documentation is available through the ZOLL website at www.zoll.com. From the **Products** menu, choose **Product Manuals**.

Unpacking





Carefully inspect each container for damage. If the shipping container or cushion material is damaged, keep it until the contents have been checked for completeness and the instrument has been checked for mechanical and electrical integrity. If the contents are incomplete, if there is mechanical damage, or if the ventilator does not pass its Self Test, U.S.A. customers should call ZOLL Medical Corporation (1-978-421-9655). Customers outside of the U.S.A. should contact the nearest ZOLL authorized representative. If the shipping container is damaged, also notify the carrier. If there is no apparent sign of mechanical damage, read instructions contained within this manual before attempting operation.











Assembly







The unit only requires that you attach the breathing circuit to begin ventilation using either internal or external power. Both the ventilator and breathing circuit are supplied clean and are ready for use on a patient.

Symbols on the Ventilator

The following symbols appear on the ventilator or in this manual:

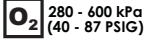





Symbol	Description
	Off
	On
	Direct Current: Identifies the location to connect external DC Power.
	Mute / Cancel: Identifies button which mutes the active alarms or cancels the parameter selection.









Symbol	Description
	Accept / Confirm: Identifies button which accepts the parameter selection.
	ESD: Warns that connector pins should not be touched.
	Identifies the dial that allows the selection of parameter values.
	Do Not Re-Use: This item should not be re-used.
	Do Not Discard: Follow all governing regulations regarding the disposal of any part of this medical device.
SN	Serial Number: Numbers following “SN” indicate the serial number.
	Defibrillation Proof: Indicates the degree of protection against electrical shock.
	BF Symbol: Protection against electric shock, Type B with floating (F-type) parts.
	MR Symbol: Identifies the use of the device's ability to perform in a MRI environment.
	Power Input Orientation: Locates the DC input identifying its point of insertion.
	Manufacturer: This symbol shall be adjacent to the name and address of the manufacturer.
	Manufacturer Date: Manufacturer Date Symbol identifies the device's date of manufacture.

Symbol	Description
	<p>Consult Instruction: Consult the instructions for use or operation manual.</p>
	<p>Refer to instruction manual.</p>
	<p>Menu icon. This icon identifies the button that, when pressed, displays a menu of options that you can select to configure the ventilator.</p>
	<p>High Pressure O₂ Connector (top faceplate icon).</p>
	<p>Exhalation Valve (top faceplate icon).</p>
	<p>Exhaust Do Not Occlude (top faceplate icon).</p>
	<p>Transducer (top faceplate icon).</p>
	<p>Gas Output -- Patient Circuit Connector (top faceplate icon).</p>

Symbols on the Ventilator's Graphical User Interface (GUI)

The following symbols appear on the ventilator's Graphical User Interface (GUI):

Symbol	Description
	Heart: Provides indication that the pulse oximeter is in use.
	Alarm Bell: Identifies the number of off-screen alarms
	Alarm Bell Outline: Identifies alarm limit settings; Identifies the on-screen alarms.
	O2 reservoir mode is in use.
LC	Leak Compensation (LC) feature is ON.
	Leak Compensation Feature is OFF.
----	Patient Detect Mode: Backup Ventilation Started.
--	Not receiving a reading.
	Attention: High Priority Alarm Active.
	Caution: Medium Priority Alarm Active.

Symbol	Description
	Warning: Low Priority Alarm Active.
	Mute: Active Alarm Audible Signal Muted.
	Speaker: Active Alarm Audible Signal
	Oxygen Supply: Oxygen Supply Connected.
	External Power: Indicates the unit is operating using an external power source.
	No External Power: Indicates the unit is operating without an external power source.
	Internal Battery: Provides indication of battery capacity and charging.
EXT BATT	Indicates that an external battery is powering the ventilator.
	No Internal Battery: Indicates when internal battery is not an available power source.
	Head with Mask: the unit is in Non-invasive Positive Pressure Ventilation (NPPV) mode.
off	Feature OFF -- feature or alarm not selected.
on	Feature ON -- feature or alarm has been selected.

Symbol	Description
srch	Search
stby	Standby.

Conventions

This guide uses the following conventions:

Within text, the names and labels for physical buttons and softkeys appear in **boldface** type (for example, “Press the **CONFIRM/SELECT** button”).

This guide uses uppercase italics for text messages displayed on the screen (for example, *LEAD FAULT*).

Warning! **Warning statements alert you to conditions or actions that can result in personal injury or death.**

Caution Caution statements alert you to conditions or actions that can result in damage to the unit.

Abbreviations

A/C - Assist/Control	I:E - Inverse ratio
AEV - Automatic Electrical Ventilator	ID - Internal Diameter
ACLS - Advanced Cardiac Life Support	L - Liters
ALS - Advanced Life Support	LCD - Liquid Crystal Display
ATLS - Advanced Trauma Life Support	LED - Light Emitting Diode
ACV - Assist-Control Ventilation	LPM - Liters Per Minute
AMC - Alarm Message Center	ml - Milliliters
APOD - Advanced Probe Off Detection	mm - Millimeter
ATPD - Atmospheric Temperature and Pressure Dry	MRI - Magnetic Resonance Imaging
b/min - Beats Per Minute	NPPV – Noninvasive Positive Pressure Ventilation
B/V - Bacterial/Viral Filter	O₂ - oxygen
BiPAP - Bilevel positive airway pressure	P_{aw} - Airway Pressure
BPM - Breaths per Minute	PEEP - Positive End Expiratory Pressure
cm H₂O - Centimeters of Water	PIP - Peak Inspiratory Pressure
CPAP - Continuous Positive Airway Pressure	PPV - Positive-Pressure Ventilation
CPR - Cardiopulmonary Resuscitation	PS - Pressure support
CPU - Central Processor Unit	psig - Pounds per Square Inch Gage
dB A- Decibel	RF - Radio Frequency
DISS - Diameter Index Safety System	RGA # - Returned-Goods-Authorization number
EMC - Electromagnetic Compatibility	RTC - Real time clock
EMV - Emergency Medical Ventilator	SIMV - Synchronized Intermittent Mandatory Ventilation
ESD - Electrostatic Discharge	SPM - Smart Pneumatic Module
FIO₂ . Fraction of Inspired Oxygen	USP - United States Pharmacopeia
HME - Heat and Moisture Exchanger	VAC - Volts AC
HMEF - Heat and Moisture Exchanger/Bacterial Viral filter combined	VDC - Volts DC
HP O₂ - High Pressure Oxygen	V_T - Tidal Volume
Hz – Hertz (as in frequency, cycles per second)	WOB – Work Of Breathing

ZOLL Ventilator Indications for Use

Ventilation

Each model of the ZOLL 731 Series of Ventilators is indicated for use in the management of infant through adult patients weighing greater than or equal to 5 kg with acute or chronic respiratory failure or during resuscitation by providing continuous positive-pressure ventilation. ZOLL Ventilators are appropriate for use in hospitals, outside the hospital, during transport and in severe environments where they may be exposed to rain, dust, rough handling, and extremes in temperature and humidity. With an appropriate third-party filter in place, they may be operated in environments where chemical and/or biological toxins are present. When marked with an "MRI conditional" label, ZOLL Ventilators are suitable for use in an MRI environment with appropriate precautions. ZOLL Ventilators are **not** intended to operate in explosive environments. ZOLL Ventilators are intended for use by skilled care providers with knowledge of mechanical ventilation, emergency medical services (EMS) personnel with a basic knowledge of mechanical ventilation, and by first responders under the direction of skilled medical care providers

Pulse Oximetry (SpO₂)

The ZOLL Ventilator pulse oximeter with Masimo Rainbow[®] SET technology is intended for use for continuous noninvasive monitoring of functional oxygen saturation of arterial hemoglobin (SpO₂), and pulse rate. The pulse SpO₂ oximeter and accessories are indicated for use on adult, pediatric, and neonatal patients during both no motion and motion conditions, and for patients who are well or poorly perfused, in hospitals, hospital-type facilities, or in mobile environments.

Features

- Portable ventilator that you can use in the hospital, aeromedical and ground transport, mass casualty situations, and extreme environments.
- Multiple modes of ventilation for use with acute or chronic respiratory failure in both intubated and non-intubated patients.
- Intuitive operator interface minimizes operator training and protects existing settings from inadvertent contact and manipulation.
- Lightweight -- less than 10 lbs (4.4 kg) -- for easy transport.
- Rechargeable battery provides over 10 hours of operation (at factory default with pulse oximeter operating).
- Operating temperature range for extreme conditions: -25 to 49°C.
- Altitude compensation from -2,000 to 25,000 ft.
- Self-contained system able to operate with or without external oxygen.
- Gas manifold design allows operation with both high and low-pressure oxygen sources. All oxygen is delivered to the patient breathing circuit.
- Sealed gas path with chemical/biological filter connected to assure safe breathing gas supply.
- Sealed case and control panel protects components from weather and fluids.
- Smart Help messages guide the operator through on-screen commands when responding to alarms.

Warnings

General

- The ZOLL Ventilator is intended for use by qualified personnel only. You should read this manual before using the device.
- Before using the ventilator on a patient, you must test the device in its normal configuration to ensure proper operation.
- Do not modify this equipment without authorization of the manufacturer.
- This operator's guide is not meant to supersede any controlling operating procedure regarding the safe use of assisted ventilation.
- Follow all governing regulations regarding the disposal of any part of this medical device, the handling of materials contaminated by body fluids, and shipment of the Li-ION batteries.

Ventilator

- The ZOLL Ventilator can operate from its internal battery or from an external power source. When using an external power source, position the supply cables to avoid accidental disconnect.
- The use of accessories and cables other than those sold by ZOLL may result in increased emissions or decreased immunity of this device.
- Portable and mobile RF communication equipment may affect the performance of this device. We describe the EMC performance for this device in the *Specifications* section of this operator's guide.
- The ventilator may cause radio interference or may disrupt the operation of nearby equipment. It may be necessary to take mitigation measures, such as re-orienting or relocating of the device or shielding the location.
- Do not connect to an electrical outlet controlled by a wall switch or dimmer.
- The protection against defibrillator depends on the use of accessories (including pulse taximeter) that are specified by ZOLL.
- Grounding:
 - Do not under any circumstances remove the grounding conductor from the power plug.
 - Do not use extension cords or adapters of any type. The power cord and plug must be intact and undamaged.
 - If there is any doubt about the integrity of the protective earth conductor arrangement, operate the taximeter on internal battery power until the AC power supply protective cover is fully functional.
- As with all medical equipment, carefully route the ventilator circuit, patient cabling, and external power cables to reduce the possibility of patient entanglement or strangulation.

- Do not use the unit during magnetic resonance imaging (MRI) scanning unless it has the appropriate “MRI conditional” label. See “Using the ZOLL Ventilator in an MRI Environment” for instructions on the use of MRI conditional units, which gives additional Warnings and Cautions.
- Do not operate the ZOLL Ventilator on a patient when the USB port is connected to any other device (you use the USB port *only* for servicing the ventilator).
- The ZOLL-supplied ventilator circuit’s labeling provides the resistance and compliance values for the circuits under normal operating conditions. If added accessories are used (e.g. humidification, filters etc.), you should assure they do not degrade the performance of the device.

Pulse Oximeter

- Do not use the pulse oximeter as an apnea monitor.
- A pulse oximeter should be considered an early warning device. As a trend towards patient deoxygenation is indicated, blood samples should be analyzed by a laboratory co-oximeter to completely understand the patient’s condition.
- Measurements: if the accuracy of any measurement does not seem reasonable, first check the patient’s vital signs by alternate means and then check the pulse oximeter for proper functioning.
Inaccurate measurements may be caused by:
 - Incorrect sensor application or use.
 - Significant levels of dysfunctional hemoglobin (e.g. carboxyhemoglobin or methemoglobin).
 - Intravascular dyes such as indocyanine green or methylene blue.
 - Exposure to excessive illumination, such as surgical lamps (especially ones with a xenon light source), bilirubin lamps, fluorescent lights, infrared heating lamps, or direct sunlight (exposure to excessive illumination can be corrected by covering the sensor with a dark or opaque material).
 - Excessive patient movement.
 - Venous pulsations.
 - Placement of a sensor on an extremity with a blood pressure cuff, arterial catheter, or intravascular line.
 - The pulse oximeter can be used during defibrillation, but the readings may be inaccurate for a short time.
- Interfering Substances: carboxyhemoglobin may erroneously increase readings. The level of increase is approximately equal to the amount of carboxyhemoglobin present. Dyes, or any substance containing dyes, that change usual arterial pigmentation may cause erroneous readings.
- Alarms: Check alarm limits each time the pulse oximeter is used to ensure that they are appropriate for the patient being monitored.

-
- Loss of pulse signal can occur in any of the following situations:
 - The sensor is too tight.
 - Excessive illumination from light sources such as a surgical lamp, a Rubin lamp, or sunlight.
 - A blood pressure cuff is inflated on the same extremity as the one with an SpO₂ sensor attached.
 - The patient has hypotension, severe vasoconstriction, severe anemia, or hypothermia.
 - Arterial occlusion proximal to the sensor.
 - The patient is in cardiac arrest or is in shock.
 - Sensors:
 - Before use, carefully read the LNCS[®] sensor directions for use.
 - Use only Masimo oximetry sensors for SpO₂ measurements. Other oxygen transducers (sensors) may cause improper performance.
 - Tissue damage can be caused by incorrect application or use of an LNCS[®] sensor for example, by wrapping the sensor too tightly. Inspect the sensor site as directed in the sensor **Directions for Use** to ensure skin integrity and correct positioning and adhesion of the sensor.
 - Do not damage LNCS[®] sensors. Do not use an LNCS[®] sensor with exposed optical components. Do not immerse the sensor in water, solvents, or cleaning solutions (The sensors and connectors are not waterproof). Do not sterilize by irradiation, steam, or ethylene oxide. See the cleaning instructions in the directions for reusable Masimo LNCS[®] sensors.
 - Do not use damaged patient cables. Do not immerse the patient cables in water, solvents, or cleaning solutions (the patient cables are not waterproof). Do not sterilize by irradiation, steam, or ethylene oxide. See the cleaning instructions in the directions for reusable Masimo patient cables.
 - Do not use the pulse oximeter sensor during magnetic resonance imaging (MRI) scanning. Inducing current could potentially cause burns. The pulse oximeter may affect the MRI image and the MRI unit may affect the accuracy of the dosimetry measurements.

Batteries

- Only use the Power Supply provided with the device. Use of any other power supply could cause damage or create a fire and/or destroy the battery and unit.
- If you witness a battery or the battery compartment starting to balloon, swell up, smoke, or feel excessively hot, turn off the unit, disconnect external power, and observe it in a safe place for approximately 15 minutes and send the unit for service. Never puncture or disassemble the battery packs or cells.

Operator Safety

- Electric shock hazard: Do not remove equipment covers. You may only perform maintenance procedures specifically described in this manual. Refer all servicing to ZOLL or a ZOLL-authorized service center.
- Possible explosion hazard if used in the presence of flammable anesthetics or other flammable substances in combination with air, oxygen-enriched environments, or nitrous oxide.
- This device is not intended for use in explosive atmospheres.
- Pins of connectors identified with the ESD warning symbol should not be touched. Always use precautionary procedures with ESD-sensitive connections.

Patient Safety

- To ensure patient electrical isolation, connect only to other equipment with electronically isolated circuits.
- Do not place the unit or external power supply in any position that might cause it to fall on the patient. Do not lift the unit by the power supply cord, ventilator circuit, or pulse oximeter patient cable.
- *Never* service the ventilator while in use with a patient.

Ferromagnetic Equipment

- **Failure to follow all instructions can result in MRI artifacts, injury to the patient or operator, or malfunction of the device.**
- **You must follow all safety procedures that are in effect for the MRI Environment. Do not use the ventilator in an MRI Environment with greater than 3T magnetic force.**
 - You must secure the unit to a suitable MRI-compatible cart -- ZOLL MRI Roll Stand (**REF 816-0731-01**); Optional IV Arm Assembly (**REF 707-0731-09**).
 - You must place the ventilator behind the 2000 Gauss field line -- approximately 2 meters to the bore opening of the MRI magnet.
 - The ventilator must be attended by a person with no other responsibility than monitoring the device and patient while in the MRI Environment.
 - You must visually monitor the ventilator for alarms at all times -- during imaging, the alarms may not be audible beyond the area immediately adjacent to the MRI.
- **Danger! Possible Missile Projection.**
 - DO NOT position any person between the bore entrance and an unsecured cart or device.
 - Lock the wheels when the rolling stand is in place.
 - We recommend that you tether the rolling stand in place when in the MRI Environment.
 - Place the ventilator and stand in its position *before* the patient is positioned on the scanner table and advanced into the bore.
 - Remove the patient from the MRI Environment before removing the ventilator and roll stand.
- **Unapproved device apparatus shall NOT be allowed in the MRI Environment, including:**
 - Pulse Oximeters sensors and cabling.
 - External AC/DC Power Supply.
 - Rolling Cart Breathing Circuit Arm.
 - Active Humidification and associated support apparatus.
- **Ensure proper configuration of the ventilator.**
 - DO NOT attach the pulse oximeter sensor to the patient and remove it from the device.
 - The ventilator should run only on battery power in the MRI Environment -- DO NOT use an external AC/DC power supply.
 - The ventilator's battery should be fully charged before entering the MRI Environment.
 - Oxygen Supply -- an aluminum, non-magnetic cylinder must provide the oxygen supply.

-
- **Ensure proper operation of the ventilator's breathing system.**
 - 12 ft ventilator circuits are available for use with the ventilator -- the additional length enables a suitable separation between the ventilator and the bore opening. (**REF** 820-130-00 -- Adult/Pediatric Wye Ventilator Circuit; **REF** 820-131-00 -- Pediatric/Infant Wye Ventilator Circuit).
 - The extended tubing length of a 12 ft ventilator circuit can result in loss of volume due to additional compressibility.
 - Set the Tubing Compliance (TC) to OFF and ensure that the patient is receiving correct tidal volume.
 - Alternatively, calculate the TC as described by the ventilator circuit's Instructions For Use (IFU) and adjust the TC value to ensure that the patient is receiving the correct tidal volume.
 - DO NOT use the 12 ft circuit with settings below 5 cmH20.
 - Ensure that the ventilator is able to maintain PEEP -- for patients with short expiratory times, the additional tubing length of the 12 ft circuit may affect system behavior.

Cautions

- Inspect the circuit very day to ensure that there is no damage or wear that could affect its performance. Remove Fluid or other biological material from the circuit or replace the circuit following the local standard of care.
- Federal law restricts this device to sale by or on the order of a physician.
- Only qualified biomedical equipment technicians should service the device.
- Internal components are susceptible to damage from static discharge. Do not remove device covers.



- Possession or purchase of this device does not convey any expressed or implied license to use the device with unauthorized sensors or cables which would, alone, or in combination with this device fall within the scope of one or more of the patents related to this device. ZOLL cannot ensure the proper functioning of this device if it is used with unauthorized sensors, cables, or patient circuits.

FDA Tracking Requirements

U.S. Federal Law (21 CFR 821) requires the tracking of ventilators. Under this law, owners of this ventilator must notify ZOLL Medical Corporation if this product is

- received
- lost, stolen, or destroyed
- donated, resold, or otherwise distributed to a different organization

If any such event occurs, contact ZOLL Medical Corporation in writing with the following information:

1. Originator's organization – Company name, address, contact name, and contact phone number
2. Model number, and serial number of the ventilator
3. Disposition of the ventilator (for example, received, lost, stolen, destroyed, distributed to another organization), new location and/or organization (if known and different from originator's organization) – company name, address, contact name, and contact phone number
4. Date when the change took effect

Please address the information to:

ZOLL Medical Corporation
Attn: Tracking Coordinator
269 Mill Road
Chelmsford, MA 01824-04105

Fax: (978) 421-0007

Telephone: (978) 421-9655

Notification of Adverse Events

As a health care provider, you may have responsibilities under the Safe Medical Devices Act (SMDA), for reporting to ZOLL Medical Corporation, and possibly to the FDA, the occurrence of certain events.

These events, described in 21 CFR Part 803, include device-related death and serious injury or illness. In addition, as part of our Quality Assurance Program, ZOLL Medical Corporation requests to be notified of device failures or malfunctions. This information is required to ensure that ZOLL Medical Corporation provides only the highest quality products.

Software License

Note: Read this Operator's Guide and License agreement carefully before operating any of the 731 Series Ventilator products.

Software incorporated into the system is protected by copyright laws and international copyright treaties as well as other intellectual property laws and treaties. This software is licensed, not sold. By taking delivery of and using this system, the Purchaser signifies agreement to and acceptance of the following terms and conditions:

1. **Grant of License:** In consideration of payment of the software license fee which is part of the price paid for this product, ZOLL Medical Corporation grants the Purchaser a nonexclusive license, without right to sublicense, to use the system software in object-code form only.
2. **Ownership of Software/Firmware:** Title to, ownership of, and all rights and interests in the system software and all copies thereof remain at all times vested in the manufacturer, and Licensors to ZOLL Medical Corporation and they do not pass to purchaser.
3. **Assignment:** Purchaser agrees not to assign, sublicense, or otherwise transfer or share its rights under the license without the express written permission of ZOLL Medical Corporation.
4. **Use Restrictions:** As the Purchaser, you may physically transfer the products from one location to another provided that the software/firmware is not copied. You may not disclose, publish, translate, release, or distribute copies of the software/firmware to others. You may not modify, adapt, translate, reverse engineer, decompile, crosscompile, disassemble, or create derivative works based on the software/firmware.

NO IMPLIED LICENSE

Possession or purchase of this device does not convey any express or implied license to use the device with replacement parts which would, alone, or in combination with this device, fall within the scope of one or more of the patents relating to this device.

Limited Warranty

ZOLL warrants the device to be free from all defects in material and workmanship for a period of one (1) year from the date of delivery to the original purchaser.

During the warranty period, ZOLL will repair or replace the device or any part which upon examination is shown to be defective. At its sole discretion, ZOLL may choose to supply a new or equivalent replacement product or refund the amount of the purchase price (on the date sold by ZOLL). To qualify for such repair, replacement, or refund, the defective device must be returned to the ZOLL Service Center within thirty (30) days from the date that the defect is discovered. This warranty does not apply if the device has been repaired or modified without the authorization of ZOLL or if the damage was caused by incorrect (off-label) use, negligence, or an accident.

Batteries, which by their nature are consumable and subjected to environmental extremes, will be warranted only for a period of ninety (90) days. Accessories, also consumable in usage, such as connecting hose and breathing circuits, are not warranted.

DISCLAIMER OF IMPLIED & OTHER WARRANTIES:
THE PRECEDING WARRANTY IS THE EXCLUSIVE WARRANTY AND ZOLL MAKES NO OTHER WARRANTY OR REPRESENTATION OF ANY KIND WHATSOEVER, EXPRESS OR IMPLIED, WITH RESPECT TO MERCHANTABILITY, FITNESS FOR A PARTICULAR PURPOSE, OR ANY OTHER MATTER. THE REMEDIES STATED IN THIS DOCUMENT WILL BE THE EXCLUSIVE REMEDIES AVAILABLE TO THE CUSTOMER FOR ANY DEFECTS OR FOR DAMAGES RESULTING FROM ANY CAUSE WHATSOEVER AND WITHOUT LIMITATION.

ZOLL WILL NOT IN ANY EVENT BE LIABLE TO THE CUSTOMER FOR CONSEQUENTIAL OR INCIDENTAL DAMAGES OF ANY KIND, WHETHER FOR DEFECTIVE OR NONCONFORMING PRODUCTS, BREACH OR REPUDIATION OF ANY TERM OR CONDITION OF THIS DOCUMENT, NEGLIGENCE, OR ANY OTHER REASON.

Service

If a unit requires service, contact the ZOLL Technical Service Department.

For customers In the U.S.A.		For customers outside the U.S.A.
Telephone:	1-973-882-1212	Call the nearest authorized ZOLL Medical Corporation representative.
Fax:	1-978-421-0010	To locate an authorized service center, contact the International Sales Department at ZOLL Medical Corporation 269 Mill Road Chelmsford, MA 01824 Telephone: 1-978-421-9655

When requesting service, please provide the following information to the service representative:

- Unit serial number
- Description of the problem
- Department using the equipment and name of the person to contact
- Purchase order to allow tracking of loan equipment
- Purchase order for a unit with an expired warranty

Returning a unit for service

Before sending a unit to the ZOLL Technical Service Department for repair, obtain a service request (SR) number from the service representative.

The Lithium ion battery should remain inside the unit. Follow directions provided on the return authorization form. Pack the unit with its cables in the original containers (if available) or equivalent packaging. Be sure the assigned service request number appears on each package.

For customers	Return the unit to
In the U.S.A.	ZOLL Medical Corporation 269 Mill Road Elmsford, MA 01824 Attention: Technical Service Department (<i>SR number</i>) Telephone: 1-978-421-9655
In Canada	ZOLL Medical Canada Inc. 1750 Sismet Road, Unit #1 Mississauga, ON L4W 1R6 Attention: Technical Service Department (<i>SR number</i>) Telephone: 1-866-442-1011

GENERAL INFORMATION

For customers	Return the unit to
In other locations	The nearest authorized ZOLL Medical Corporation representative. To locate an authorized service center, contact the International Sales Department at ZOLL Medical Corporation 269 Mill Road Chelmsford, MA 01824-4105 Telephone: 1-978-421-9655

Chapter 2

Product Overview

This chapter provides an overview of the ZOLL Ventilator, which you can use to manage infant through adult patients with acute or chronic respiratory failure or patients that you are resuscitating by providing continuous positive-pressure ventilation. (See *Indications for Use* in Chapter 1.)

This chapter describes the ZOLL Ventilator models, providing a list of common features and attributes, as well as descriptions of each model. This chapter also provides more detailed descriptions of the following ventilator features:

- Controls and Indicators
- Display Screen
- Pneumatic Design
- Fresh Gas Intake
- Connector Panel
- Ventilator Circuits
- Pulse Oximeter
- Power Sources

ZOLL Ventilator Models

The ZOLL Ventilator is available as the AEV, EMV+, and Eagle II models. The ventilator offers a range of ventilatory modes to support EMS, military, air transport, and hospital transport needs.



The AEV ventilator is designed for managing ventilator support patients during ambulance transport. Its ventilation modes (AC, CPAP with PS, and BL) are specifically chosen to be consistent with pre-hospital care provider's operating procedures.

The EMV+ ventilator's rugged design makes it ideal for use in emergency vehicle and air transport of patients. It has a wide range of ventilation modes, such as AC, SIMV, CPAP, and BL.

The Eagle II ventilator adapts the design of for the EMV+ for use by emergency departments and intra-hospital transport. Its design also allows it to be mounted onto walls or onto specified boom arms and roll stands as well as gurneys.



The ZOLL ventilators have been approved for use in MRI suites. The EMV+ and Eagle II ventilators have MRI-compatible variants available. The MRI-compatible ventilators can operate in 3.0 Tesla environments and can be placed approximately 6 1/2 ft. from the bore opening for easy and safe access to the patient. See Chapter 3 for more information regarding safe operation in the MRI Environment.

ZOLL Ventilator Features

The ZOLL Ventilator models have these common features:

- Rugged design
- Weight: ~10 lbs
- 10 hour battery life
- Rapid charger to achieve 90% battery capacity in 2 hours
- High performance internal compressor
- Smart Help messages
- Integral SpO₂ (Masimo)
- Airworthiness Release
- Daylight visible display
- Oxygen efficient
- Supports infant, pediatric, and adult patients
- Limited 1 year warranty

ZOLL Ventilator Device Description

The following illustration shows the ZOLL Ventilator's main features:

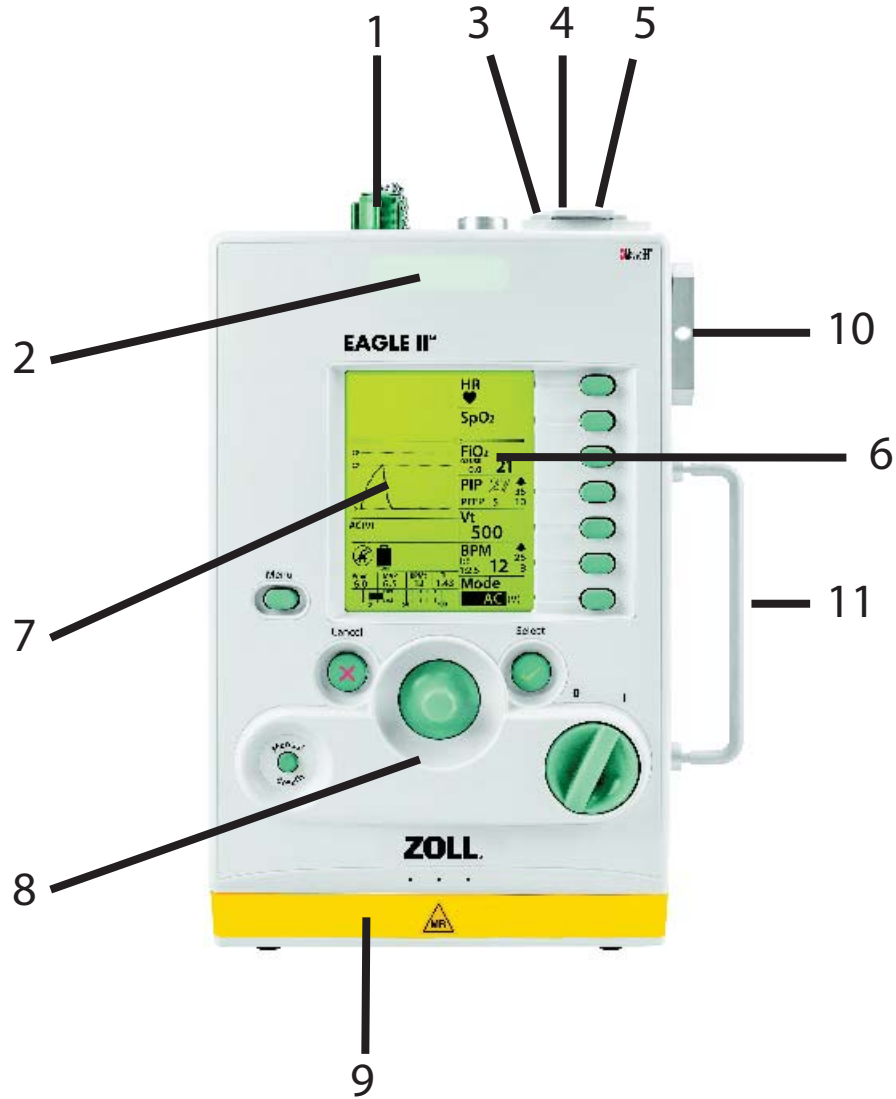

	Item	Description
Top		
1.	Oxygen Inlet	Connects the unit to an external oxygen source
2.	Status Indicator LED Array	Lights up to indicate status of the unit, connected to alarms
3.	External Power Input Connector	Connects the unit to an external power source
4.	USB Connector	Connects the unit to a USB drive or USB compatible device
5.	Pulse Oximeter Connector	Connects the unit to a Pulse Oximeter sensor
Front		
6.	LCD Display	Displays the unit's settings, patient data, and alarm information
7.	Alarm Message Center	Displays active alarms and mitigation information
8.	Control Panel	Access to the unit settings
Bottom		
9.	Battery Compartment	Contains the unit's rechargeable lithium ion battery
Side		
10.	Fresh Gas/Emergency Air Intake	Allows the unit's internal compressor to take ambient air and acts as an anti-asphyxia valve
11.	Handle	

Controls and Indicators

The ZOLL Ventilator has controls and indicators that facilitate ease of use and visibility in all operating environments.

This ventilator's control panel includes a display screen (liquid crystal display -- LCD), an LED array, and the controls that you use to set up and manage the ventilator.

The ventilator's controls consist of the following:

1. **Power On/Off Switch** -- turns the ventilator on and off.
2. **Parameter buttons** -- chooses parameter values.
3. **Menu Button** -- displays the main menu.
4. **Selection dial** -- changes the value of the highlighted parameter value.
5. **Mute/Cancel button** -- mutes audible alarm indicators and cancels parameter entries.
6. **Accept/Select button** -- accepts parameter value entries, Pop Up conditions or menu selections.
7. **Manual Breath/P Plat (Plateau Pressure) button** -- issues a manual breath, and for the EMV+ and Eagle II models, provides the ability to conduct a plateau pressure maneuver.

The ventilator's indicators consist of the following:

8. **LCD Display** -- Brightness and backlight controls are available in the main menu (we describe the display in more detail later in this chapter).
9. **LED Array** -- Indicates status of the ventilator's operation by lighting red, yellow, or green LED's.

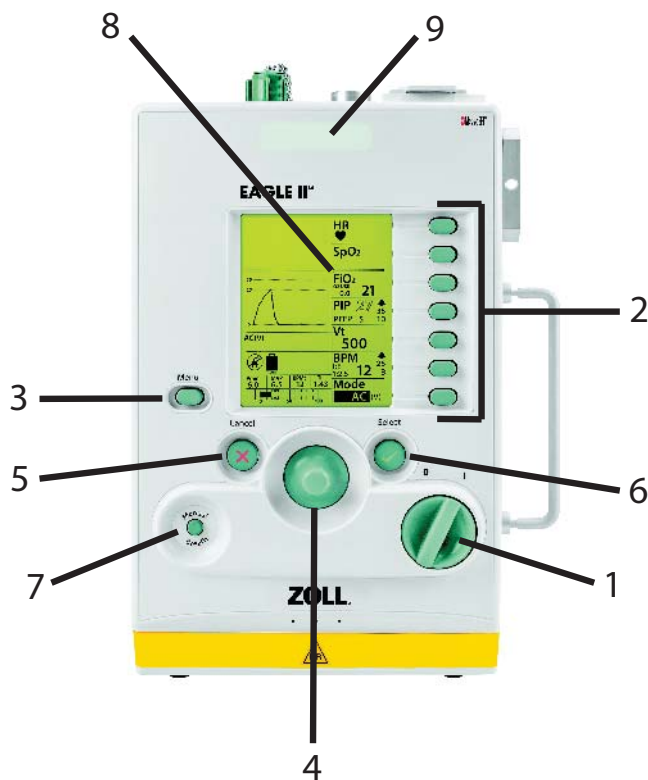

Display Screen

The ZOLL Ventilator's display screen has four functional areas:

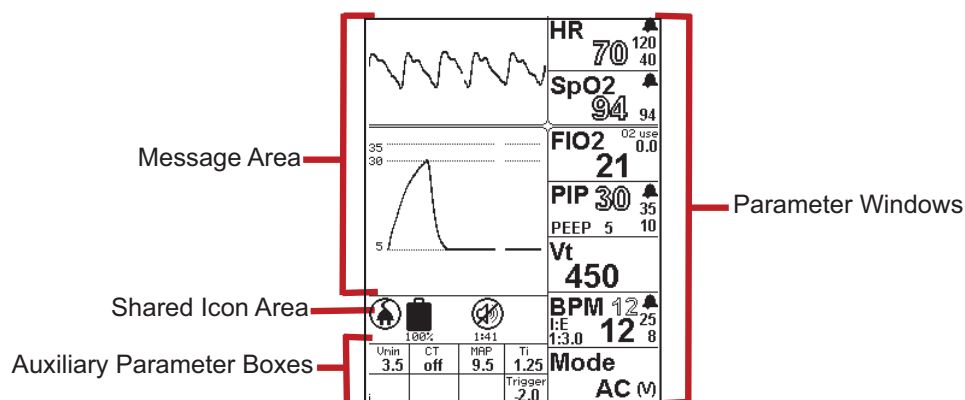

Message Area

The display screen's message area can display the following:

- **Airway Pressure and Pleth Waveform Plots** -- Under normal operation (as in the example above), the message area displays plots for airway pressure and, when the pulse oximeter is connected, the Pleth waveform.
- **Menus** -- Displays the Main Menu after you press the menu button on the ventilator's control panel, or displays a parameter's context menu (which appears after you *press and hold* the associated parameter button on the control panel). When a plot is necessary to facilitate a parameter adjustment, the message area displays both the plot and the parameter's context menu.
- **Alarms** -- When an alarms occur, the message area displays Smart Help messages that identify the alarms and describe possible causes and actions that you can take in response.
- **Popup Windows** -- Display information that assists you when adjusting parameter values.

Parameter Windows

Parameter windows display the measurements, alarm limits, and associated parameters for their labeled parameters. Parameter values that you can adjust, such as alarm limits, appear as solid text. Parameter values that you cannot adjust, such as measurements taken by the ventilator, appear as outlined text. We provide information on adjusting parameter values in Chapter 4, "Using the ZOLL Ventilator."

Shared Icon Area

Directly below the message area, the unit displays icons that indicate

- Power source (external power or internal battery)
- Battery Charge Status
- Oxygen Supply attached
- Alarm Muted/Audible

Auxiliary Parameter Boxes

Some parameters have values that the ventilator displays in the parameter boxes at the bottom of the display screen. You can adjust these values using the parameter's context menu.

Pneumatic Design

The ZOLL Ventilator includes an oxygen valve and a compressor to provide the gas to the output port. The system includes transducers for pressure measurements including input supply pressure and barometric readings.

The wye circuit is part of the ventilator's pneumatic system. The inspiratory side of the wye circuit provides gas to the patient. The expiratory side exhausts directly to atmosphere without returning to the ventilator. The ventilator pneumatically controls the exhalation valve and a transducer within the ventilator measures the airway pressure.

The following image is a diagram of the ventilator's pneumatic design.

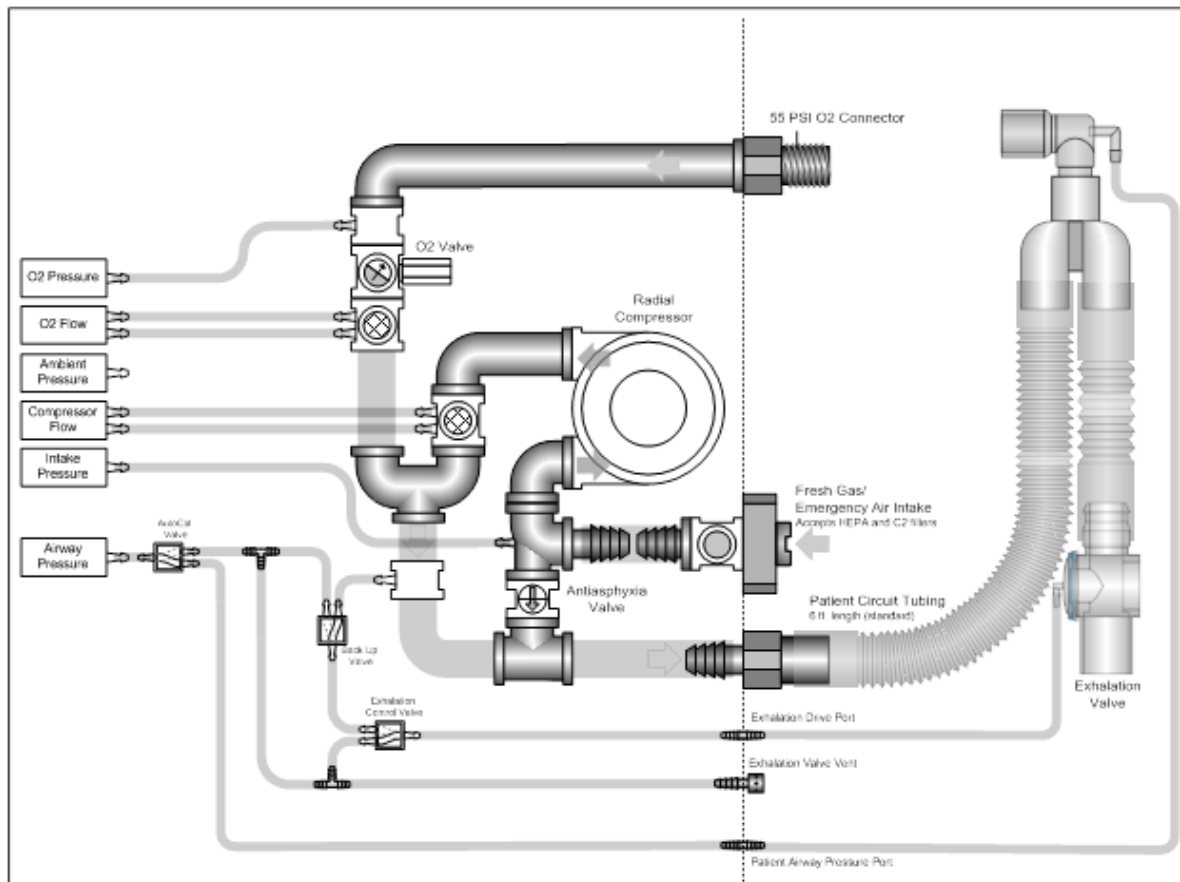

Fresh Gas Intake and Attachments

The fresh gas intake, which is located on the side of the ventilator, allows ambient air into the unit's internal compressor. The intake also acts as an anti-asphyxia valve that enables the patient to breath ambient air should the ventilator fail.

The fresh gas intake contains a particulate filter and permits the operator to connect either a bacteria/viral or a chemical/biological filter depending on ambient conditions

ZOLL provides an O₂ Reservoir Kit to allow for low flow oxygen supply to the ventilator. An oxygen concentrator source provides oxygen to the O₂ reservoir.

Top Panel

The ZOLL Ventilator's top panel appears as follows:

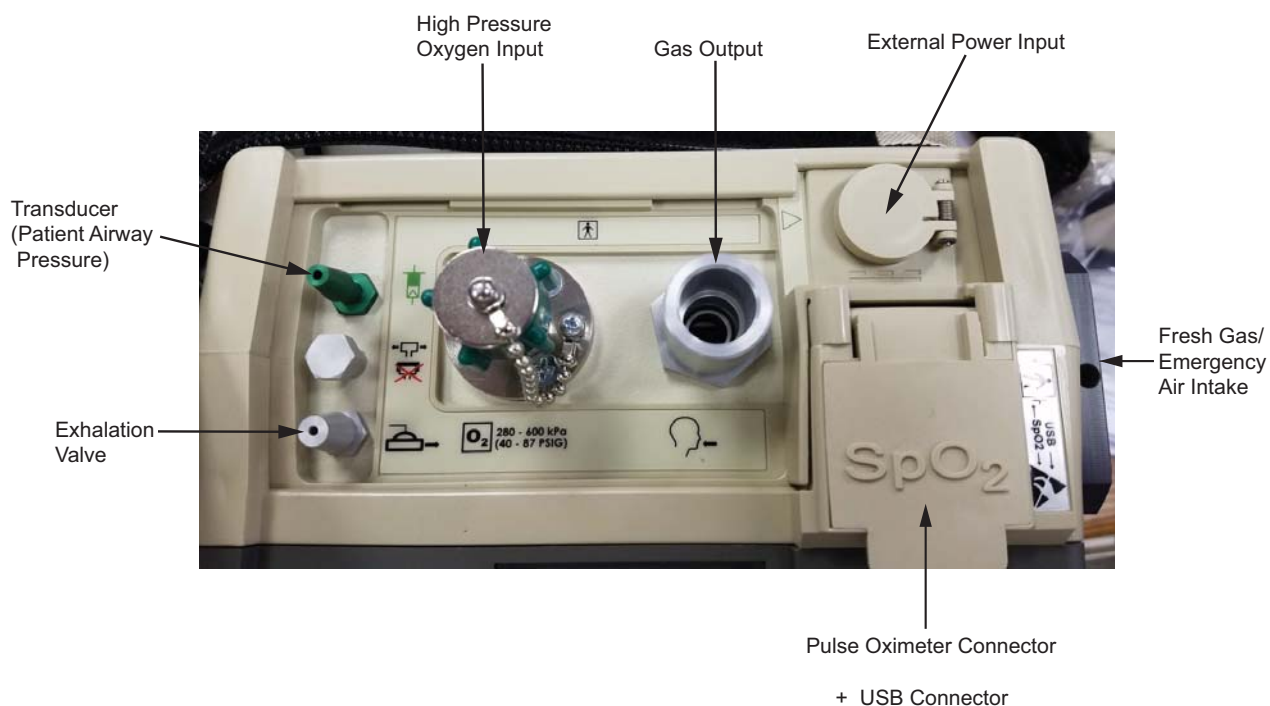

The oxygen hose, ventilator circuit, external power, and pulse oximeter attach to the top panel of the ventilator. The USB port is only used when servicing the unit.

Oxygen Input: High Pressure Gas Supply

The external high pressure gas source connects to the device using the high pressure oxygen input port.

The device attaches to a regulated supply of 40 to 87 PSIG (280 to 600 kPa). The maximum flow rate of the oxygen supply is 100 liters per minute. This supply can be from a medical grade oxygen system or oxygen cylinder (USP).

The OXYGEN IN fitting has a male oxygen Diameter Index Safety System (D.I.S.S.) thread.

Note: If external oxygen is connected, the gas pressure must be at least 41-psig (± 2 psig) when the device performs Self-Check after you power on the unit.

High Pressure Oxygen Supply Hose

A standard 6 foot oxygen hose is available to make the connection to the high pressure oxygen source. The hose is has compatible fittings between the device an the source identified for use. (Also see Chapter 6 “Operating Environments”). Hoses are available from ZOLL, or a suitable alternative as described below can be used as indicated in the table below.

High Pressure Hoses need to comply with ISO standards		
Device Side Connections	Hose Attributes	Supply Side Connections
DISS	6 ft (maximum 20ft) Green or White (as determined by local regulations) Non-conductive	Quick Disconnect, DISS, etc.

Figure 2-1 Ventilator Gas Sources

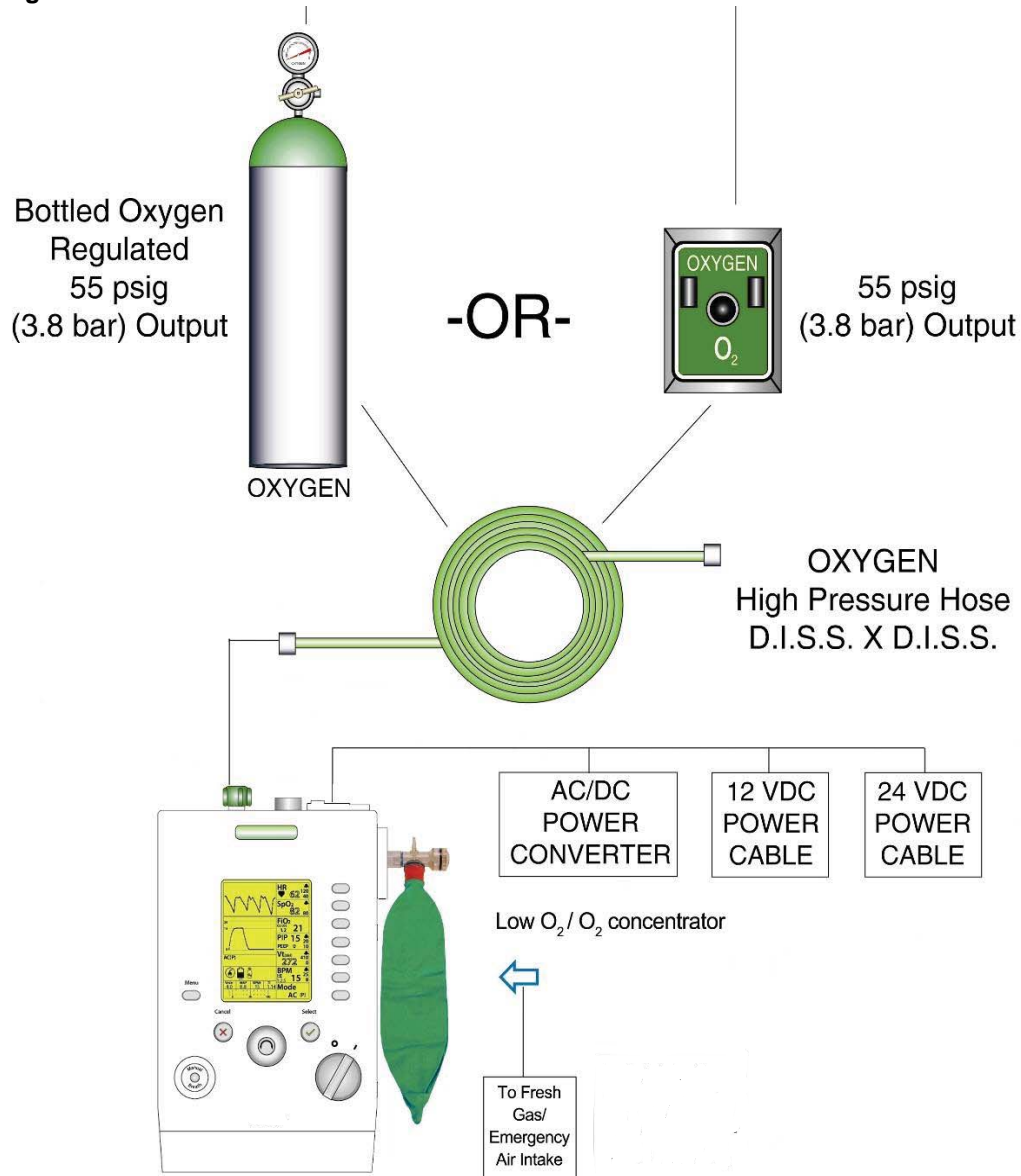

Ventilator Circuits

The ZOLL Ventilator operates using a standard disposable ventilator circuit.

The Ventilator circuit attaches to the device using three ports on the top of the device.

- **Gas Output** -- connects to the ventilator circuit using 22 mm ID corrugated hose. The connector is a 22 mm male conical connection.
- **Transducer (Patient Airway Pressure)** -- connects to the ventilator circuit using a 3/16 inch ID transducer tubing. The barb-type connector is colored a green/blue to distinguish it from the other connectors.

-
- **Exhalation Valve** -- connects to the ventilator circuit using 1/4 inch ID exhalation valve tubing. The barb-type connector is clear anodized aluminum to distinguish it from the other connectors (the 1/4 inch ID ventilator circuit exhalation valve tubing is clear).

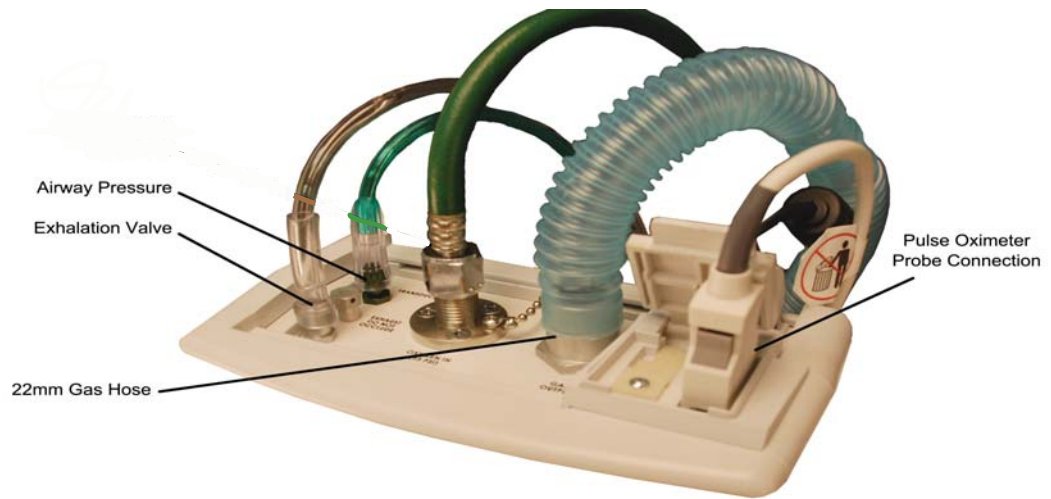

Ventilator Circuit Connections

Ventilator Circuit Types

The ZOLL Ventilator can use 6 ft or 12 ft ventilator circuits to support adult, pediatric, and infant patients.

:

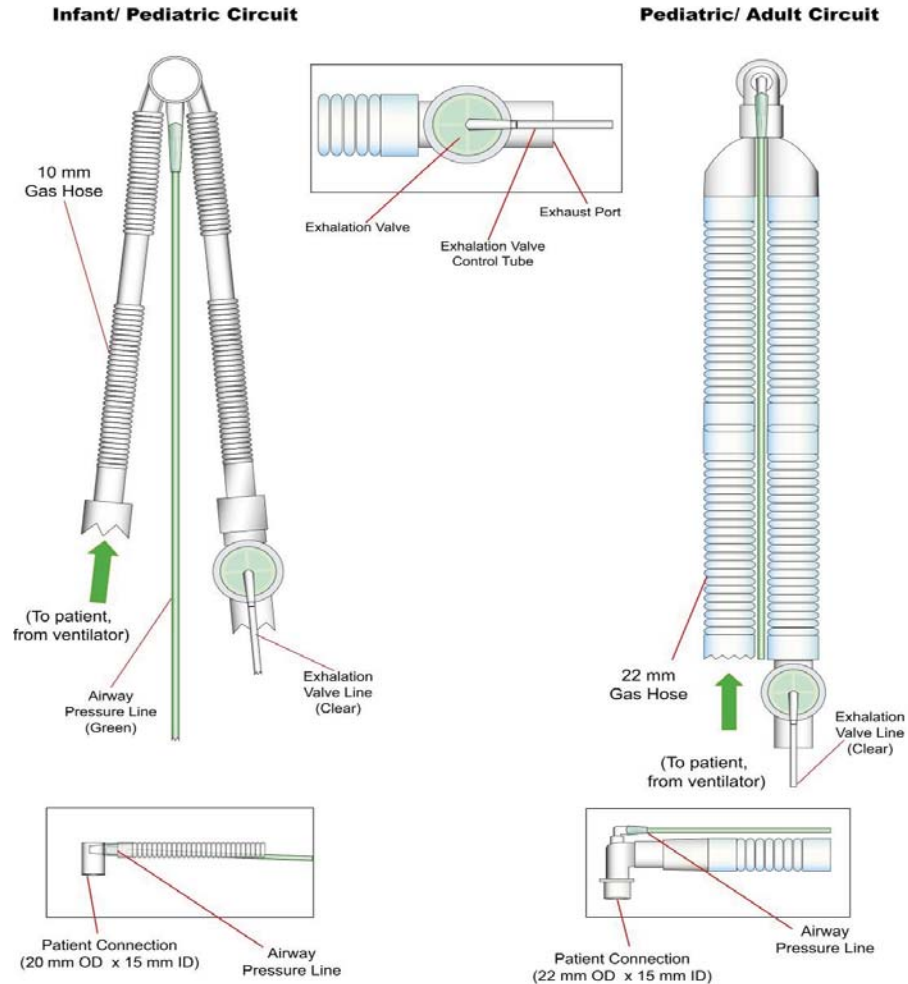

Ventilator Circuits

ZOLL provides the following circuit types:

- Pediatric/Adult, 6 ft (REF 820-0106-XX)
- Infant/Pediatric, 6 ft (REF 820-0107-XX)
- Pediatric/Adult, 12 ft (REF 820-0130-XX)
- Infant/Pediatric, 12 ft (REF 820-0131-XX)

Caution

Always dispose of the circuit after single patient use following the institutional guidelines for biologically contaminated material. Reusing the circuit can result in cross contamination between patients.

Pulse Oximeter Sensors

The Masimo Pulse Oximeter is an optional function of the ZOLL Ventilator. When the appropriate sensor is connected, the pulse oximeter provides continuous noninvasive monitoring of arterial hemoglobin (SpO₂) and pulse rate (measured by the SpO₂ sensor) for adult, pediatric and infant patients.

The Masimo LCSN series of probes are approved for use with the ventilator. The Accessory table in Appendix A lists the sensors which are available for use with the ZOLL Ventilator.

Power Sources

The ZOLL Ventilator can operate using external power or it can operate powered by its internal Lithium Ion Battery.

The external AC/DC Power Supply that ZOLL provides with the ventilator delivers a DC input to the device of 24V at 4.2A. When this external power source is present, the ventilator automatically charges its internal battery while operating.

The external AC/DC Power Supply is a universal supply that can operate with an input of 100-240 VAC 50/60 Hz. The external supply can also power the device when provided with a 400 Hz input.

You should only use the external power supply provided with the ventilator when connecting to AC power. This power supply provides both Class I and Class II protection.

Operating Using External DC Power

The ZOLL Ventilator can also operate using external DC power. When connected to a standard vehicle DC outlet using either the 12 or 28 VDC Power Cable that ZOLL provides, the ventilator automatically charges its internal battery while operating.

Note: The input connector of the ventilator accepts DC voltages between 11.8 to 30.0 VDC.

Caution	When using the standard vehicle DC outlet, do not jump start the vehicle during operation of the ventilator.
----------------	--

Operating Using Battery Power

When an external power failure occurs, the ventilator automatically switches to its internal battery for operating power and activates the *EXTERNAL POWER FAILURE* alarm; there is no interruption in operation or loss of any alarms. When external power returns, operating power automatically switches to the external power source.

In the event that the ventilator needs to be shutdown, turn the POWER switch to the OFF ("O") position. If this fails to work or puts the patient or operator at possible risk, disconnect the device from the external power source.

Chapter 3

Setting Up the ZOLL Ventilator

This chapter describes how to set up the ZOLL Ventilator. It lists the tasks required to set up the ventilator for safe, effective use, and describes each task in detail.

Warning! You must always properly set up the ventilator before use. Failure to do so can result in inadequate care or death of the patient.

To set up the ZOLL Ventilator, you must perform the following tasks:

1. Attach the Ventilator Circuit
2. Attach the High Pressure Oxygen Supply (Optional)
3. Inspect Fresh Gas Intake Filters
4. Connect Fresh Gas Intake Attachments
5. Select the Ventilator's Power Source
6. Power on the Ventilator
7. Select Start Up Default Values
8. Select Operating Mode (Optional)
9. Change Parameter Values
10. Change Ventilator Settings
11. Perform Operational Test
12. Attach the Pulse Oximeter Probe (Optional)
13. Attach Patient

We describe how to perform these tasks in the following sections of this chapter.

Warning! Always follow standard of care, which includes preparations to bag the patient. **DO NOT** start up the ventilator with the patient attached.

1. Attach the Ventilator Circuit

Select the correct ventilator circuit for the patient and environment (as we describe in the previous chapter). *Always follow the instructions included with the circuit.*

Attach the ventilator circuit to the ventilator's top panel. Connect

- The 22 mm corrugated hose to the ventilator's gas output
- The green/blue 3/16 inch ID airway pressure line to the pressure transducer
- The clear 1/4 inch ID exhalation valve control line to the exhalation valve fitting.

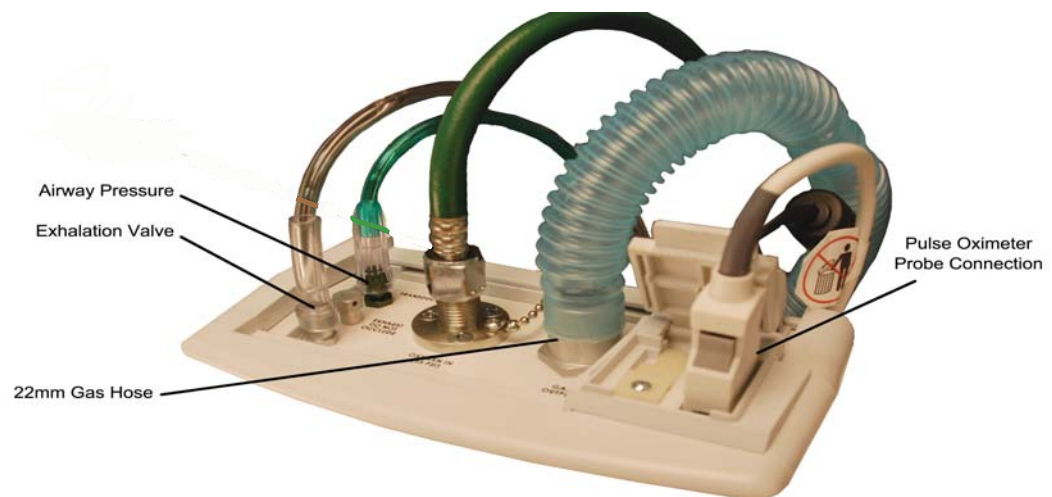

Ventilator Circuit Device Connections

2. Attach the High Pressure Oxygen Supply (Optional)

Since the ventilator includes an internal compressor, the attachment of a high pressure oxygen supply is optional.

Review the high pressure supply requirements that we describe in Chapter 2, and use the oxygen hose to attach the ventilator's oxygen inlet to the high pressure gas source.

Note: Use only with medical-grade (USP) oxygen. When using with an oxygen cylinder, the cylinder must be secured.

Note: The O₂ Hose is either colored green or white, depending on country specifications.

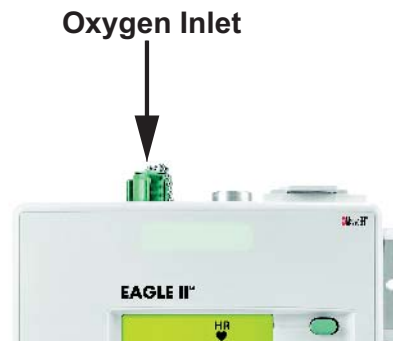

3. Inspect Fresh Gas Intake Filters

The fresh gas intake is the gas source for the ventilator's internal compressor. The ventilator normally operates with two built-in filters:

1. Removable Foam Filter (REF 465-0028-00)
2. Fresh Gas Intake Disk Filter (REF 465-0027-00)

Inspect the filters and, if dirty, replace them (See Chapter 7, "Replacing the Ventilator's Filters").

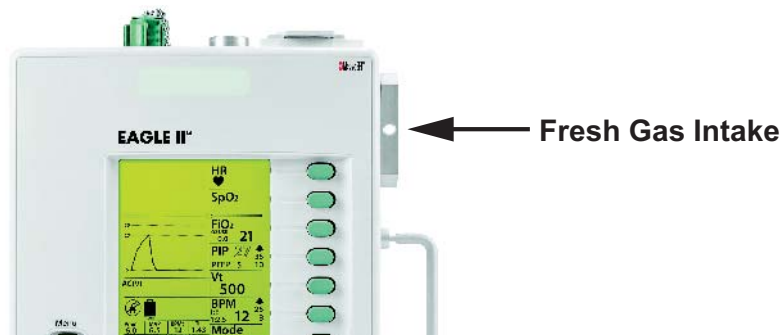

4. Connect Fresh Gas Intake Attachments

The operating environment of the ventilator may require you to connect the following attachments to the Fresh Gas Intake:

Oxygen Reservoir Bag

If the ventilator will use oxygen from low-flow sources, you may choose to attach an Oxygen Reservoir Bag Assembly (**REF** 704-0004-00).

Bacterial/Viral (BV) Filter

If the ventilator will operate in an environment where the patient is at risk from cross contamination or airborne pathogens, you may choose to attach a BV filter (See Chapter 6, “Using the ZOLL Ventilator in Hazardous Environments”).

Chemical/Biological C2A1 Filter

If the ventilator will operate in a contaminated environment, you may choose to attach a chemical/biological C2A1 filter (See Chapter 6, “Using the ZOLL Ventilator in Hazardous Environments”).

5. Select the Ventilator's Power Source

The ZOLL Ventilator can run using one of the following power sources:

1. Internal 14.4V lithium ion (Li Ion) rechargeable battery with 6.75 Ah capacity (fully charged, the battery provides 10 hours of operation at factory default settings with pulse oximeter operating at 25C).
2. External AC/DC Power Supply that ZOLL provides (100-240 VAC 50/60 and 400 Hz with an IEC 320 style AC input connector. The AC/DC Power Supply provides a DC output of 24V at 4.2A.
3. External DC power from a standard vehicle DC outlet using either the 12 or 28 VDC Power Cable that ZOLL provides to connect the ventilator to the DC outlet. The ZOLL Ventilator's input connector accepts DC voltages between 11.8 to 30.0 VDC.
4. An external battery.

The ZOLL Ventilator uses external power when available rather than its internal battery pack. When an acceptable external power source is present, the ventilator automatically charges the internal battery while the unit operates. When an external power failure occurs, the unit automatically switches to its internal battery for operating power and activates the *EXTERNAL POWER FAILURE* alarm; there is no interruption in operation or loss of any alarms. When external power returns, operating power automatically switches from internal power to the external source.

In the event that the device needs to be shutdown, turn the **POWER** switch to the OFF ("O") position. If this fails to work or puts the patient or operator at possible risk, disconnect the device from the mains power.

To connect the ventilator to an external power source, connect an AC/DC Power Supply plug to the unit's External Power Input and an acceptable electrical outlet.

Connecting the Power Supply

Connect the external power cable to the ventilator as follows:

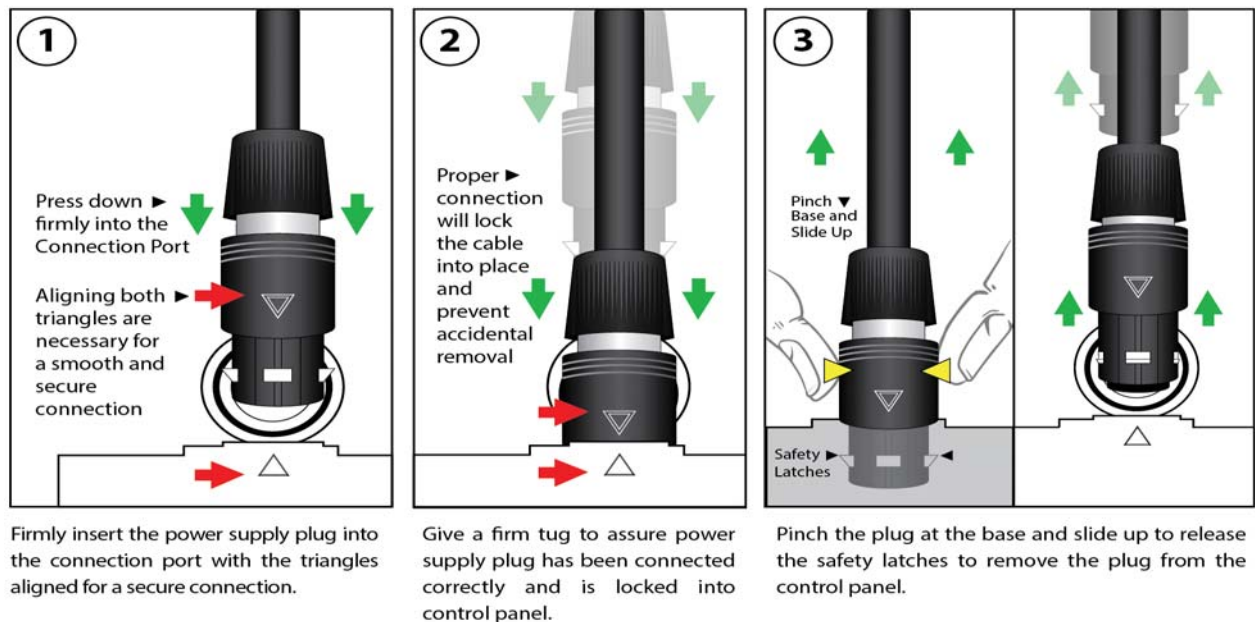

Connecting and Disconnecting the Power Supply

Caution Do not twist the power cable connection plug. Pinch the plug and slide up to release the safety latches. Failure to do so may damage the power connection plug and prevent it from functioning.

Warning! If the power supply, power cable, or power connection plugs are damaged or become damaged during use, immediately disconnect the power cable from external power and the power supply assembly.

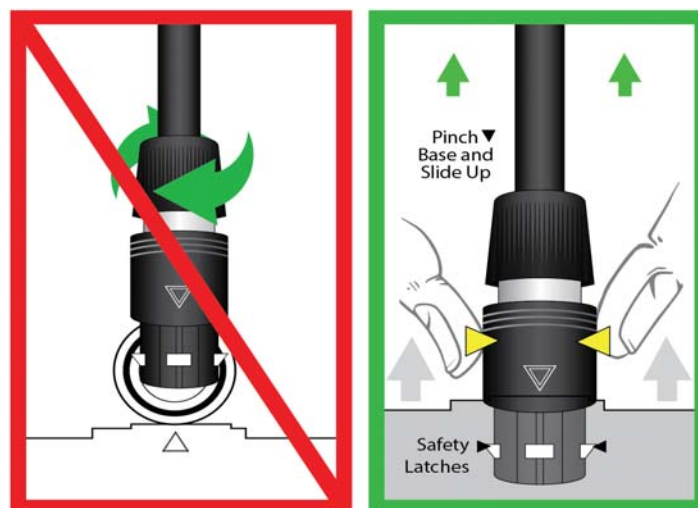

Power Supply Latching

6. Power On the Ventilator

To power on the ventilator, turn the **POWER** switch to “1”.



Power Switch

After powering on, the unit performs its Self Check procedure, which checks for preexisting alarm conditions and the operation of the pneumatic system, internal communications, and power system. After completing the Self Check, the ventilator begins to operate immediately, and monitors the presence of alarms continuously.

During start-up, the ventilator’s alarms are disabled for 120 seconds to allow you to properly adjust the patient circuit, pulse oximeter, and ventilator settings without distraction.

7. Select Start Up Default Values

When you power on the ventilator, the Start Menu appears, through which you choose the appropriate parameter default values for the patient. You can select the following patient parameter defaults:

- **Adult**
- **Pediatric**
- **Mask CPAP** -- Continuous Positive Airway Pressure (CPAP)
- **Custom** -- Values saved in a previous session
- **Last Settings** -- Values set for the patient last using the device before powering down

Note: The ventilator can may be configured to automatically select the Adult parameter defaults at start up.

Adult Default Parameter Values

The Adult default parameter values are as follows:

Adult Parameter Default Values

Mode	AC (V)
BPM	12
I:E	1:3
VT	450
PEEP	5
PIP Limit	35
FIO2	21

Pediatric Default Parameter Values

The Pediatric default parameter values are as follows:

Pediatric Parameter Start-Up Defaults

Mode	SIMV (P)
BPM	20
Ti	0:6
PIP	20
PEEP	4
PIP Limit	30
FIO2	21

Mask CPAP Default Parameter Values

The Mask CPAP default parameter values are as follows:

Mask CPAP Parameter Start-Up Defaults

Mode	CPAP
Backup BPM	12
Backup I:E	1:3.0
Backup PIP	20
PEEP	4
PIP Limit	30
FIO2	21

To select the unit's default parameter values, highlight one of the above settings in the Start Menu and press the **ACCEPT/SELECT** button. To operate with parameter values that differ from the default values, use the unit's Parameter buttons (see the "Changing Parameter Values" section later in this chapter).

Note: You can configure the ventilator to automatically select Adult parameter defaults at start up.

To adjust the parameter settings, always work from the lowest parameter button, Mode, to the highest button, HR. The values that you select in a lower parameter window may affect the values that appear in higher parameter windows

Warning! Never use the Noninvasive Positive Pressure Ventilation (NPPV) modes on a patient that is NOT spontaneously breathing and/or may stop spontaneously breathing. CPAP and BL are intended for *ventilatory support*, NOT *ventilation*.



When an NPPV mode is in operation, the head with mask icon appears in the location used by the speaker/mute icons. Low and Medium priority alarms cause this head with mask icon to disappear.



It reappears when Low priority alarms are muted.

When Medium priority alarms are muted, the muted speaker icon appears.

8. Select Operating Mode (Optional)

The ventilator offers four operating modes that you can select to optimally manage the patient (each mode can use either pressure or volume targeting):

1. **AC** (Assist/Control) -- The patient receives either controlled or assisted breaths. When the patient triggers an assisted breath, they receive a breath based on either the volume or pressure target.
2. **SIMV** (Synchronized Intermittent Mandatory Ventilation)-- The patient receives controlled breaths based on the set breathing rate. Spontaneous breaths are either unsupported demand flow or supported using Pressure Support. (This mode is not available in the AEV[®] unit.)
3. **CPAP** (Continuous Positive Airway Pressure) -- The patient receives constant positive airway pressure while breathing spontaneously. Spontaneous breaths are either demand flow or supported using Pressure Support.
4. **BL** (bilevel) -- the ventilator provides two pressure settings to assist patients breathing spontaneously: a higher inhalation pressure (IPAP) and a lower exhalation pressure (EPAP).

To select the operating mode, press the **Mode** parameter button, turn the **selection dial** to highlight the mode you want to use, and press the **Accept/Select** button.

When transitioning from active ventilation to NPPV modes, or from NPPV Modes to active ventilation modes, the following parameter/alarm limit may be adjusted:

Alarm/Parameter
Low BPM Alarm
High BPM Alarm
Low Airway Pressure Alarm
PEEP
V _T High Limit
V _T Low Limit
Rise Time
Pressure Support

Warning! **The transition into NPPV automatically sets the rise time to 3, which may be too fast for infants and small children. Before using the ventilator with an infant or small child, you should always configure the ventilator appropriately before attaching the patient.**

Note: An alarm triggers when you connect the patient to the ventilator while the Start Menu is still active. To resolve the alarm, you must select a mode of ventilation and configure the device appropriately for the patient. In addition, you should perform the Operational Test procedure before reconnecting the patient to the device.

9. Change Parameter Values

If the patient requires parameter values that differ from the default values, you can use the parameter buttons to change these values, as necessary. To change the parameter values, press the Parameter buttons to display the primary parameter and secondary parameter values, or Press and hold the parameter button to display the parameter's context menu. Use the **selection dial** to adjust the highlighted parameter. Press the **Accept/Select** button to implement the change.

10. Change Ventilator Settings

The Menu button displays the Main Menu, which allows you to change various Ventilator settings, such as the contrast or brightness of the unit's Display Screen (*LCD Contrast/LCD Brightness*).

When you press the Menu button, the Main Menu appears:

- **Alarm Config**
- **Powerup Settings**
- **LCD Contrast**
- **LCD Brightness**
- **GMT Offset**
- **Unit Info**
- **Alarm History**

11. Perform Operational Test

Before attaching the patient to the ventilator, you must perform an Operational Test to ensure that the breathing circuit is properly attached and that the primary patient safety alarms, such as PATIENT DISCONNECT and AIRWAY PRESSURE HIGH are functioning properly.

Operational Test Procedure

Press the MANUAL BREATH button; gas should flow out of the patient connection each time the button is pressed.

The minimum period between manual breaths is limited by the tidal volume and the time required to complete a full exhalation based on the I:E ratio.)

Close the patient port with a gloved hand. During inspiratory phase, the HIGH AIRWAY PRESSURE LIMIT alarm should activate after 2 breaths that reach the PIP High Limit.

If the AIRWAY PRESSURE HIGH alarm fails to activate, ensure that all of the tubing connections are secure, the exhalation valve is closing during inhalation, and that the High Airway Pressure Limit is set to 35 cm H₂O or less.

After a breath or two, release the patient port while allowing the ventilator to operate. The PATIENT DISCONNECT alarm should activate.

Partially close the patient port to reset the PATIENT DISCONNECT alarm. With no other alarms occurring, remove external power from the ventilator. The EXTERNAL POWER LOW/DISCONNECT alarms should activate. Reconnect external power to reset alarms.

If either the HIGH AIRWAY PRESSURE, PATIENT DISCONNECT, or EXTERNAL POWER LOW/DISCONNECT alarms fail to activate, continue to manually ventilate the patient, replace the ventilator, and send the unit in for service.

If operating using the internal battery, verify that the Battery icon indicates sufficient available battery capacity remains to support the anticipated duration of operation. If not, begin ventilation and find an alternate source of power.

The trigger automatically adjusts when the PEEP is changed.

Until you have determined that the ventilator is functioning properly and that the ventilator parameters are set correctly for the patient, do not connect the patient to the ventilator.

12. Attach the Pulse Oximeter Probe (Optional)

The pulse oximeter becomes operational in all ventilator modes when its cable and sensor are properly attached to the SpO₂ connector (during start up, the pulse oximeter is on standby -- the SpO₂ and HR Parameter Windows display *stby*).

To operate the pulse oximeter, connect the sensor probe to the patient and the cable to the SpO₂ connector on the top of the ventilator as shown in the following illustration:

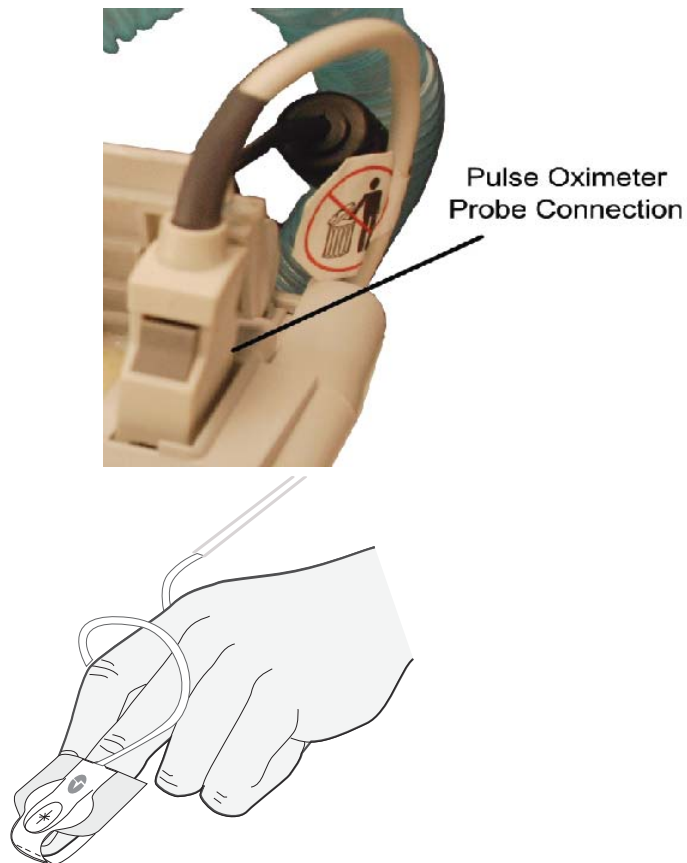

Connecting the Pulse Oximeter Sensor

The monitoring function begins automatically when a valid patient signal is detected for > 10 seconds.

For more information about the Masimo pulse oximetry technology that the ZOLL Ventilator uses, see Appendix C, *Pulse Oximeter Principles*.

13. Attach Patient

After you confirm that the ventilator is operating correctly, detach the test lung (if used in the Operational Test) from the ventilator circuit.

Attach the patient to the ventilator using the appropriate connector (tracheal tube or laryngeal mask) to the ventilator circuit.

Chapter 4

Using the ZOLL Ventilator

This chapter describes how to use the ZOLL Ventilator.

Effective operation of the ventilator requires understanding of the following information:

- The ZOLL Ventilator Interface and Parameter Windows
- Changing Parameter Values
- Selecting Ventilation Mode Options
- Using the Pulse Oximeter
- Managing Pop Up Messages
- Managing Alarms

The Ventilator Interface

The ZOLL Ventilator uses a Graphical Use Interface (GUI) to display the parameter settings and patient readings.

Changing Parameter Values

The ZOLL Ventilator helps you to manage the patient by organizing ventilatory parameters in *parameter windows* on the right side of the display screen. These parameter windows display the primary and secondary parameters and the alarm settings for that parameter. In addition, set values and measurements appear in the auxiliary boxes at the bottom of the display screen.

Additional settings used to manage the patient are applied using the context menu for parameter group.

The sections below describe the parameter windows and the associated context menus for each parameter. A table addresses availability of the parameter and its use in the device models.

The parameter window values are chosen with the parameter button:

Single Press: chooses primary parameter

Multiple Presses: chooses the secondary parameter and alarm limits

Press and Hold: chooses the context menu

To prevent setting of parameter values that are outside the typical clinical range of settings, the ZOLL Ventilator displays Pop Up messages that ask if you are sure you would like to set the parameter beyond the typical range. We describe Pop Up messages in more detail in Chapter 5.

Parameter Buttons

The parameter windows, from lowest to highest, are

- **Mode**
- **BPM** (Breaths per Minute)
- **V_T** (Tidal Volume -- V_T)
- **PIP** (Peak Inspiratory Pressure)
- **FIO₂**
- **SpO₂**
- **HR** (Heart Rate)

Mode

The ZOLL Ventilator allows you to select different ventilation modes that you can select to optimally manage the patient:

- **AC (Assist/Control)** -- The patient receives either controlled or assisted breaths. When the patient triggers an assisted breath, they receive a breath based on either the volume or pressure target.
- **SIMV (Synchronized Intermittent Mandatory Ventilation)** -- The patient receives controlled breaths based on the set breathing rate. Spontaneous breaths are either unsupported demand flow or supported using Pressure Support.

-
- **CPAP (Continuous Positive Airway Pressure)** -- The patient receives constant positive airway pressure while breathing spontaneously. Spontaneous breaths are either demand flow or supported using Pressure Support.
 - **BL (Bi Level)** -- the ventilator provides two pressure settings to assist patients breathing spontaneously: a higher inhalation pressure (IPAP) and a lower exhalation pressure (EPAP).

Press the **Mode** parameter button to highlight the current ventilation mode. Press the **Mode** parameter button again to select volume or pressure targeting which is shown as either “(V)” for volume or “(P)” for pressure.

Breath Target

The selected ventilation mode, and the selection of breath target (volume or pressure) predetermines the parameter availability for the BPM, Vt, and PIP parameter windows.

Volume targeting assures a constant volume is delivered to the patient in the inspiratory time using a constant flow.

Pressure targeting provides a constant airway pressure for the duration of the inspiratory time

Leak Compensation

Leak Compensation provides flow during the expiratory phase to maintain the baseline pressure in patients that are breathing spontaneously, but have a leaking airway or facemask

To avoid nuisance alarms in patients with active leaks, Leak Compensation suppresses the following alarms:

- Incomplete Exhalation (Alarm #3091)
- Insufficient Flow (Alarm #2095)

The following table lists the ventilator modes and their availability in the ZOLL ventilator models, and gives the options and ranges for the ventilation mode parameters:

Parameter Window		Options / Range	Availability/Notes	Models
Primary Value	Mode	AC		All
		SIMV		EMV+, Eagle II
		CPAP		All
		BL		All
Secondary parameter Values	Target	(V) or (P)	AC and SIMV modes	All (SIMV not available with AEV)
	LC	On or OFF Default off	AC(P), SIMV(P) modes BL modes	EMV+, Eagle II
		Default on	CPAP	All
Alarms	N/A			
Measured Value	N/A			
Apnea Back Up Context Menu			CPAP and BL modes	
Apnea Back Up	BPM	1 to 80		All
Apnea Back Up	PIP	10 to 80		All
Apnea Back Up	I:E , Ti	1:1 to 1:99, 0.1 to 3	Control selected in context BPM Context Menu	All

BPM (Breathes Per Minute) -- Timing and Rate Management

The BPM parameter describes the number of breaths-per-minute. The selected ventilation mode determines when this value is a setting or a measurement.

Assisted and controlled breaths are time-cycled. For spontaneous breaths, the ventilator uses the percent of the peak flow to terminate the breath being delivered (flow cycled).

Control Parameter

The Ti (Inspiratory Time) parameter adjustment sets the inspiratory time for the control and assisted breaths (AC and SIMV modes). For volume targeted breaths, the Ti parameter affects the gas flow rate (the device displays Pop-Up messages when the minimum and maximum flow rate values have been reached).

Rise Time

When PS is selected, you can adjust the time it takes to reach PIP. You can specify an index of 1 (shortest) to 10 (longest). The device uses the PIP waveform as a reference when selecting the Rise Time for the patient.

You should reassess and readjust the Rise Time settings after the patient is placed on the ventilator and initially stabilized. To minimize patient's work of breathing and potential for pressure overshoots, you must take the following into consideration when setting the Rise Time:

- Patient's respiratory pattern
- Patient's comfort
- Patient's flow demand
- Resistance (Mechanical/Physiological)
- Compliance characteristics

The Rise Time for a passive lung is driven primarily by airway resistance, and is fairly independent of compliance.

Resistance	Rise Time
5	1
20	3
50	5
200	10

An adult patient with high Resistance may benefit from a Rise Time setting of 3 to 4 for optimal breath delivery. Rise Times of 8 to 10 are optimized for infants and are flow limited. (The infant circuit is not intended for flows > 60 LPM.)

Cycle Off % Parameter

The ZOLL Ventilator transitions from inspiratory to expiratory phase when the flow drops below a set percentage of the peak flow.

You can adjust the Cycle % value to account for patient leaks.

Note: The longest duration of a spontaneous breath is 5 seconds. At the end of this time, the ventilator ends flow and opens the exhalation valve.

Clinicians must carefully assess the patient's response when applying the adjusted % -- you must adjust the % value carefully to optimize patient ventilatory support and comfort.

The Cycle Off % parameter is principally for noninvasive modes where a much higher setting is required to cycle the breath properly in the presence of a leak. If a higher value is not used and there is a leak, the system tends to time cycle at 5 seconds instead of flow cycle (if the leak flow is higher than 25% of the peak flow, the cycle threshold is never crossed.)

If there is no leak, increasing the Cycle Off % parameter causes breaths to cycle sooner, and deliver less volume. If you set the Cycle Off % parameter too high, the breath ends early relative to patient effort, which may lead to the triggering of a second breath.

Spont Ti Limit Parameter

The Spont Ti Limit parameter provides an additional method to operate the delivery of breaths and maximize patient comfort.

Manual Breath/Plateau Pressure Button

The Manual Breath/Plateau Pressure button delivers a breath only if pressed during the expiratory phase when the airway pressure drops to the PEEP target.

In AC and SIMV, pressing the Manual Breath/Plateau Pressure button delivers a breath defined by the settings.

In CPAP and BL, pressing the Manual Breath/Plateau Pressure button delivers a breath defined by Apnea Back-Up settings.

Press and hold the Manual Breath/Plateau Pressure button to perform a plateau pressure maneuver.

BPM Parameter Settings

The following table gives the options and ranges for the BPM parameters:

Parameter Window		Options / Range	Availability/Notes	Models
Primary Value	BPM Breaths per minute	0 to 80	Volume Target: Control Setting Pressure Target: Measured	All
Secondary parameter Values	Ti (sec) or I:E	Ti 0.1 to 3.0 or 1:1 to 1:99	See BPM context menu: Control Parameter	All
		Ti 0.1 to 5.0 or I:E 4:1 to 1:99	Inverse I:E	EMV+, Eagle II
Alarm Limits	High breath rate	20 to 99, off		
	Low breath rate	2 to 40		
Measured Value	Minute Volume Vmin (ml)	0 to 99.9		
BPM Context Menu				
Control Parameter	Default I:E	1:1 to 1:99, 0.3 to 3	The control value is shown in the Parameter window, the dependent value is shown in the Auxiliary Box.	All
		Ti 0.1 to 5.0 or I:E \$:1 to !:99	Inverse I:E	EMV+, Eagle II
Rise Time -	Default #	1 to 10	Auxiliary Box	All
Cycle Off % (% Cycle)	Default 25%	10 to 70%	Auxiliary Box	All
Spont Ti Limit	Default Adult = 3.00 Infant = 2.00 Mask CPAP = 3.00	0.30 to 4.00		

Vt (Tidal Volume)

The Vt parameter gives the tidal volume (ml) delivered to the lung. The selected ventilation mode determines if this value is a setting or a measurement.

In volume targeted modes, pressing the VT parameter button highlights the current set tidal volume and enables it to be changed.

In pressure targeted breaths, the delivered tidal volume is shown as outlined text and is based on the patient pulmonary mechanics. The VT High and Low Limits are also available as secondary parameters.

Warning! **In NPPV, a VT that is lower than anticipated given the patient's size may be an indication that the patient is not able to adequately spontaneously ventilate.**

The ventilator circuit is part of the breathing system of the ventilator. Tubing compliance of the circuit is a physical property that affects the tidal volume delivered to the patient. The ZOLL Ventilator allows you to adjust the compliance value of the circuit (see Chapter 6 for more information).

Note: In the CPAP-NPPV, the V_T delivered and V_{min} may be overestimates of the true volume going to the patient when leaks are present. The O_2 Use values accurately display the O_2 use, though the amount used is more than if no leak was present.

Warning! **If significant leaks are present during NPPV modes, the V_T delivered and V_{min} shown may be overestimates of what is actually being delivered to the patient. The adequacy of ventilation should be assessed using an alternate method.**

The following table gives the options and ranges for the Vt parameters:

Parameter Window		Options / Range	Availability/Notes	Models
Primary Value	Vt ml	50 to 2000	Volume Target: Control Setting Pressure Target: Measured	All
Secondary				
Alarm Limits	High Vt	50 to 2000, Off		
	Low Vt	5 to 500, Off		
Vt Context Menu				
Tubing Compliance (CT)	Default : Off	OFF, Adult, Infant	Auxiliary Box	All
Adult	Default: 1.60	0 to 3.50	The changed value is not retained when the device is turned OFF	All
Infant	Default: 0.50	0 to 2.00		All
Compliance Volume (ml)	(Measured value)	0 to 349		All

PIP (Peak Inspiratory Pressure) -- Pressure Management

In volume targeted modes, the primary field shows the delivered PIP as outline text. In pressure targeted modes, the PIP target is displayed and is adjustable. The PIP High Limit, PIP Low Limit, and PEEP are also available as secondary parameters.

During the exhalation phase, the ventilator opens the exhalation valve when the pressure is above the PEEP setting, and closes it when below the setting.

In Bilevel Ventilation Mode, the ventilator provides noninvasive ventilation with the ability to manage the patient by adjusting the IPAP and EPAP parameters.

Caution Set the trigger level to minimize the work of breathing for the patient and prevent auto-triggering. Set the Vt alarms to bracket average tidal volume so that the unit detects pending respiratory failure (low tidal volumes) and excessive leaks (high tidal volumes).

Spontaneous/Assisted Breath Trigger

The Spontaneous/Assisted Breath Trigger is preset to -2.0 cm H₂O and can be adjusted from -6.0 to -0.5 cm H₂O below the baseline (PEEP) pressure. In order to initiate a spontaneous or assisted breath, the patient must generate -2.0 cm H₂O. When the pressure drop is detected, an assisted breath is delivered.

The trigger automatically adjusts when the PEEP is changed.

Plateau Pressure

Press and hold the Manual Breath/Plateau Pressure button to perform a plateau pressure maneuver.

Pressure Management

The following table gives the options and ranges for pressure management.

Parameter Window		Options / Range	Availability/Notes	Models
Primary Value	PIP cm H ₂ O	10 to 80	Volume Target: Measurement Pressure Target: Control Setting PIP values greater than 60 cm H ₂ O require the operator to perform a separate confirmation.	All
Secondary Value	PEEP	0 to 30	AC Modes (ACV, SIMV, CPAP, BL Modes)	All
		3 to 30		
	PS	0 to 60	Spontaneous Breaths (SIMV and CPAP)	
	EPAP	3 to 30	Spontaneous Breaths	
	IPAP	6 to 60	BL	
Alarm Limits	High PIP	20 to 100	PEEP cannot be within 5 cm H ₂ O of the <i>PIP High Limit</i> setting.	All
	Low PIP	3 to 35, Off		All
Measured Value	Mean Airway Pressure	0 to 99.9		All
	MAP			
	Paw Waveform	0 to 100		All
PIP Context Menu				All
Breath Trigger (Assisted, Spontaneous)	Default : -2	-6 to -0.5	Adjustment Increments: .5	All

FIO₂ (Fraction of Inspired Oxygen) -- Oxygen Delivery Management

Pressing the **FIO₂** parameter button highlights the current FIO₂ value and enables you to adjust it. There are no adjustable secondary parameters. The default values at start up is 21% whether oxygen is present or not. If an FIO₂ value greater than 21% is saved and used for Power Up settings, the unit start ups with that saved FIO₂ value if high-pressure oxygen is present. If high-pressure oxygen is *not* present, the unit starts up with FIO₂ = 21% and *O₂ SUPPLY PRESSURE LOW* alarm is *not* activated. The secondary display in the parameter window is O₂ Use¹. This is the flow (liters/min) of high pressure oxygen used by the unit to support the patient at the current settings. O₂ Reservoir mode is indicated on the display with a plus “+” sign next to the FIO₂ value when this mode is active. (The “O₂ Use” value does not include oxygen use in the O₂ Reservoir.)

The following table lists the options and ranges for the FIO₂ parameter:

Parameter Window		Options / Range	Availability/Notes	Models
Primary Value	FIO₂ %	21 to 100	All breaths are delivered from the compressor at 21% All breaths are delivered from the High Pressure O ₂ Source at 100%	All
Secondary Values	Not Applicable			All
Alarm Limits	Not Applicable			All
Measured Values	O ₂ Use (L/min)	0 to 99.9	Shows when High Pressure Oxygen Supply is present.	All
FiO₂ Context Menu				
O ₂ Reservoir	Default : off	Off / On	“+” icon indicates when “on” for low flow oxygen.	All

1. $O_2 \text{ Use} = ((FIO_2 - 0.21) / 0.79) * \text{Minute Volume}$ where FIO₂ is represented as a fraction and minute volume is the actual minute volume (controlled and spontaneous breaths * tidal volume).

SpO₂ -- Using the Pulse Oximeter

The primary use of the device is as a ventilator -- the pulse oximeter operates *only* when the device is providing ventilation.

The following conditions can affect the pulse oximeter reading:

- The sensor is too tight.
- There is excessive illumination from light sources such as a surgical lamp, a bilirubin lamp, or sunlight.
- A blood pressure cuff is inflated on the same extremity as the one with a SpO₂ sensor attached.
- The patient has hypotension, severe vasoconstriction, severe anemia, or hypothermia.
- There is an arterial occlusion proximal to the sensor.
- The patient is in cardiac arrest or is in shock.

The SpO₂ display is active only when the pulse oximeter is connected. The pulse oximeter is in standby (and displays *stby* in the parameter window) when

- No SpO₂ sensor is connected
- The sensor is off the patient during start up
- You place the pulse oximeter in standby

Note: You can place the pulse oximeter in standby only when the probe is disconnected from the patient. A valid signal automatically brings the pulse oximeter out of standby.

SpO2 Parameter Values

Pressing the **SpO2** parameter button highlights the Low SpO₂ Alarm Limit and enables its value to be changed. The default low SpO₂ value at start up is 94%. The SpO2 parameter uses the same Context Menu as the HR parameter.

The following table gives the options and ranges for the SpO2 parameter:

Parameter Window		Options /Range	Availability/Notes	Models
Primary Value	SpO2 %	84 to 100	Measurement	All
Secondary Values	Not Applicable			
Alarm Limits	Low Limit			
Measured Values	Pleth Waveform	86 to 99, Off		
SpO2 Context Menu (note same as HR Context Menu)				
Pulse Ox	Default : Standby	Standby, Off, On		All
Fast SAT	Default : Off	Off/On	Fast SAT enables rapid tracking of arterial oxygen saturation changes by minimizing the averaging. This mode is clinically applicable during procedures when detecting rapid changes in SpO ₂ is paramount such as induction, intubation, and sleep studies.	
Sensitivity	Norm	Max	Norm adjusts the pleth signal sensitivity. Max interprets and displays data for even the weakest of signals. Max is recommended during procedures and when clinician and patient contact is continuous.	
APOD	Off	Off, On	When on, this mode improves detection of the "probe off patient" condition, but reduces the ability to acquire a reading on patients of low perfusion.	
Averaging	8 Seconds	2 to 4, 4 to 6, 8, 10, 12, 16 Seconds	Adjusts the SpO2 and HR averaging durations.	

Signal Strength	Measured Value	0 to 20	Current signal strength value, not adjustable. A value of zero indicates that no measurement is available. This value helps clinicians place sensors on optimal sites	
Signal IQ	Measured Value	Bar Graph	Bar graph displays the relative reliability of the pulse oximeter signal.	

HR (Heart Rate)

The HR (Heart Rate) parameter window displays the patient’s heart rate when the pulse oximeter is working and the sensor is attached.

Pressing the **HR** parameter button highlights the High Heart Rate alarm limit and enables its value to be changed. Pressing the **HR** button a second time highlights the current value of the Low Heart Rate Alarm limit and enables its value to be changed. Both limits are adjustable by 1 b/min. The default value at start up for the high alarm limit is 120 BPM (Beats Per Minute); the low alarm limit is 40 BPM.

The following table gives the options and ranges for the HR parameter:

Parameter Window		Options / Range	Availability/Notes	Models
Primary Value	HR %	0 to 240	Measurement - Heart Icon blinks at the beat rate.	All
Secondary Values	Not Applicable			
Alarm Limits	High Limit	80 to 240, Off		
	Low Limit	30 to 79, Off		
Measured Values	Pleth Waveform			
HR Context Menu (note same as SpO2 Context Menu)				

Managing Pop Up Messages

To prevent the setting of parameter values that are outside the typical clinical range of settings, the ventilator presents Pop Up messages that ask if you are sure you would like to set the parameter beyond the typical range.

When a message occurs, you are asked to press the **Accept/Select** button before you can adjust a parameter beyond the typical range. Pop Up messages are also used to alert you that certain settings are not permitted. In addition, Pop Up messages can call for you to press **Accept/Select** to acknowledge that you are entering configurations where certain alarms are being suppressed, turned “off”, and/or canceled.

We provide a comprehensive list of pop up messages in Chapter 5, “Alarms.”

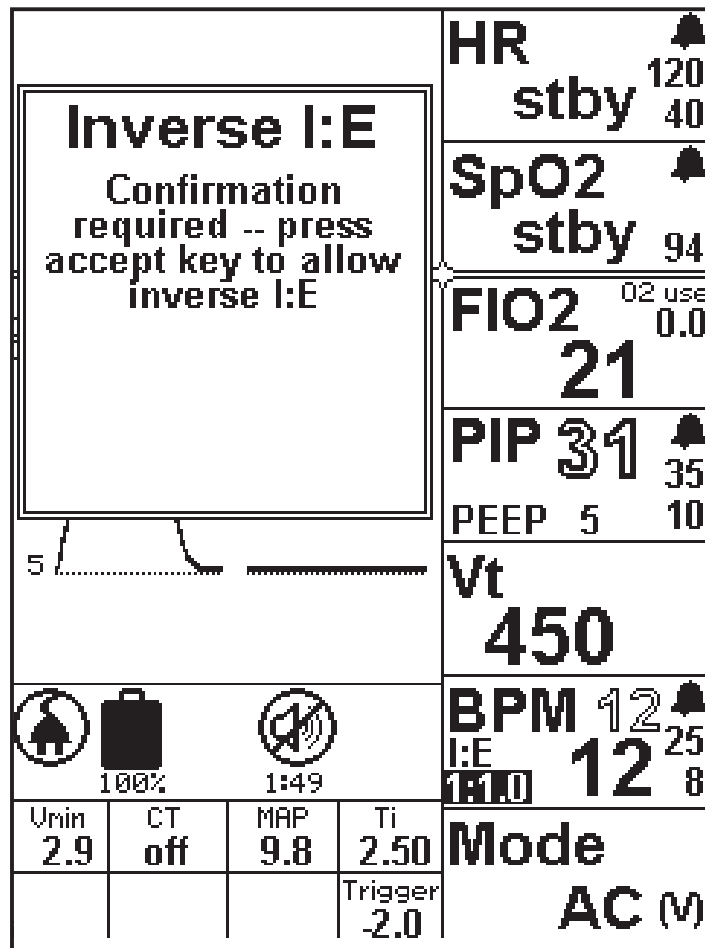

Pop Up Message Example

Managing Alarms

The ZOLL Ventilator uses Smart Help™ messages that provide a comprehensive suite of alarms. Smart Help messages alert operators and guide their actions to resolve alarm conditions and ensure patient safety.

At the onset of an alarm, the screen displays the alarm name and then a series of context-sensitive Smart Help messages, which describe the possible cause and resolution of that alarm. When multiple alarms occur, the unit prioritizes alarms and displays those alarms that indicate the greatest risk to the patient first.

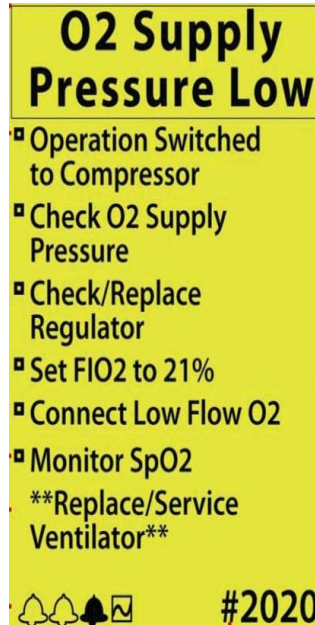

Smart Help Example

The previous illustration provides an example of what the device displays when there are several alarms. The displayed Alarm message corresponds to the dark alarm bell at the bottom of the display. You can cycle through the various alarms by turning the ventilator’s selection dial. If there are less than 5 alarms, this alarm list also includes a “plot” icon, where the alarm screen is replaced by the Pulse Pleth/Time and Pressure/Time plots.

We describe Alarms in detail in Chapter 5, “Alarms” and provide a comprehensive reference.

Smart Help Messages

At the onset of an alarm, the Alarm Message Center (AMC) in the upper left-hand corner of the device's LCD screen displays a Smart Help message. The Smart Help message displays the alarm name with a series of messages to help the operator resolve the alarm. The AMC indicates the number of active alarms as a series of Alarm Bell icons at the bottom with each bell indicating an active alarm. The ventilator prioritizes alarms and displays the alarm indicating the greatest risk first. All messages are context-based and suggest what is causing the condition and how it can be resolved.

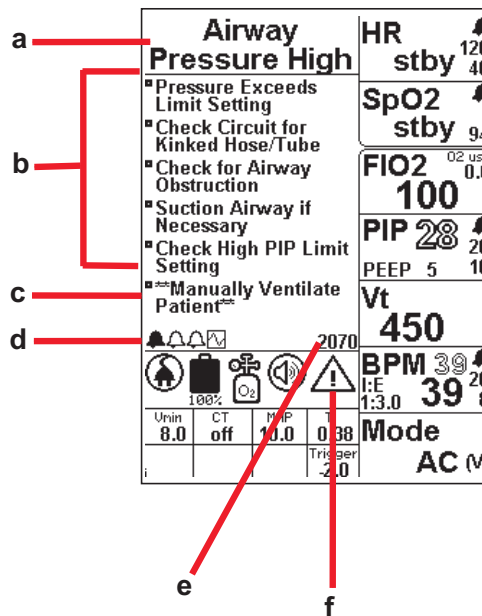

Smart Help Display

Smart Help messages contain the information and instructions for all active alarms, such as in the previous example:

- a. **Alarm Name:** Describes the nature and/or cause of the fault or failure. The Alarm Name appears at the top of the AMC. When more than one alarm occurs at the same time, the unit prioritizes them based on patient safety.
- b. **Mitigation/Resolution Instructions:** Instructions for the operator as to how the alarm state may be resolved.
- c. **If not Resolved Instructions area:** Instructions for the operator on what to do if they cannot resolve the alarm state. The instruction is always shown in the following format ***Message...***.
- d. **Alarm Icons:** For each active alarm, an alarm bell appears. When multiple alarms are active, the number of bells corresponds to the number of alarms. The alarm in the AMC is demonstrated as the solid bell. To view each active alarm, turn the selection dial to scroll through all active alarms. If there are less than 5 alarms, the plot icon also appears.
- e. **Service Code:** Each alarm has a 4 digit number associated with it, which helps the operator indicate the specific alarm when communicating with technical support.
- f. **Attention Warning Icon:** Identifies the severity of the alarm: Low, Medium, or High priority.

Alarm Priorities

Alarm priorities define the operational state of the device regarding its ability to provide mechanical ventilation. The alarm priority determines what effect pressing the **MUTE/CANCEL** button has. There are three priorities:

- **High Priority:** Mechanical ventilation under operator control is no longer possible. This alarm category requires immediate intervention by the operator. This includes system failure alarms where the CPU has failed and a backup has taken over to sound the audible and visual alarms. It also includes when the device is turned on and there is no internal or external power source. Pressing the **MUTE/CANCEL** button has no effect on the High Priority alarm. The alarm can only be silenced by turning off the ventilator.
- **Medium Priority:** Mechanical ventilation is active or is possible (maybe for a finite period of time), but there is a failure/fault with the patient, ventilator circuit, a pneumatic subsystem, or pulse oximeter. This alarm category requires immediate intervention by the operator. Pressing the **MUTE/CANCEL** button mutes Medium Priority alarms for 30 seconds. If after 30 seconds the alarm-causing condition still exists, the audible alarm recurs until it is muted again for another 30 second period or resolves.
- **Low Priority (Advisory):** Safe mechanical ventilation is active, but there is a fault that the operator must be aware of to ensure safe management of the patient and/or ventilator. Low Priority alarms present themselves with both an audible and yellow LED alarm signal alerting the operator to the condition. Pressing the **MUTE/CANCEL** button cancels the audible signal. If the alarm is not resolved, the yellow LED remains illuminated to remind the operator of the fault or failure. You can cancel some Low Priority alarms to avoid nuisance alarms.

If the alarms are Low Priority, then the Pleth and Pressure/Time plots appear permanently on the screen when the alarms are muted. If the alarms are Medium Priority, the unit cycles through each Medium Priority Alarm for a 20 second period. You can use the selection dial to select a particular Medium Priority Alarm and/or Plot for 20 seconds, after which the above cycling rotation resumes. New Alarms can overwrite the screen at any time.

The first digit in the service code indicates the alarm priority:

- 1###: High Priority alarms
- 2###: Medium Priority alarms
- 3###: Low Priority alarms

Silencing Alarms

The operator may decide, based on their clinical assessment, to silence certain alarms that, in the given situation, are considered “nuisance” alarms and do not assist in the safe management of the patient. Before any alarms can be silenced, the operator receives a Pop Up message asking them to confirm their understanding that the alarm is no longer available in the current operating session.

Alarm Preemptive Mute upon Power up

When the unit is first powered up, certain patient circuit alarms are preemptively muted for 120 seconds, to allow the operator time to get the patient circuit properly adjusted without nuisance alarms.

Note: During this preemptive mute of this audible alarm, the LED alarm light and alarm message are still indicated.

There is a countdown timer located under the muted alarm symbol, showing how much time of the 120 seconds is remaining. The alarms that have this preemptive mute are:

Service Code	Alarm Name
2062	Exhalation Fault
2070	Airway Pressure High
2071	Low Airway Pressure
2072	High Tidal Volume
2073	Low Tidal Volume
2074	High Breath Rate
2075	Low Breath Rate/Apnea
2076	Apnea
2090	PEEP Leak
2095	Insufficient Flow
2100	Patient Disconnect
2170	Spontaneous Breath-PIP High
2171	Spontaneous Breath-PIP Low
2172	Spontaneous Breath-V _T High
2173	Spontaneous Breath-V _T Low
2300	Pulse Ox Module Failed
2301	Internal Communication Failed
2314	SpO2 Sensor Off Patient
2401	SpO2 Low
2410	Heart Rate High
2411	Heart Rate Low (Pulse Rate Low)

Service Code	Alarm Name
3300	SpO2 Shutdown (MS 11 Failure-Monitor Not In Use)
3301	SpO2 Shutdown (Communication Failure EMV-Pulse Ox-Monitor Not In Use)
3310	No SpO2 Sensor Connected (No Sensor Detected)
3311	Defective Sensor
3312	SpO2 Pulse Search
3313	SpO2 Signal Interference
3315	Too Much Ambient Light
3316	Invalid SpO2 Sensor (Unrecognized Sensor)
3317	Low SpO2 Perfusion (Low Perfusion)
3318	Low SpO2 Perfusion (Poor SpO2 Signal)

Turning Off Alarms at Extreme Range Limits

If the operator sets the following alarm limits to their extreme range, the ventilator turns off the indicated alarms after Pop Up message confirmation:

1. High Breath Rate (Alarm #2074).
2. PIP Low (Alarms #2071, 2171) -- the device automatically turns off these alarm limits in NPPV mode.
3. V_T High (Alarms #2072, 2172) -- the device automatically turns off these alarm limits in NPPV mode.
4. V_T Low (Alarms #2073, 2173) -- the device automatically turns off these alarm limits in NPPV mode.
5. Low SpO2 (Alarm #2410)
6. High Heart Rate (Alarm #2410)
7. Low Heart Rate (Alarm #2411)

If an alarm has been turned *off* and is then modified, but is not accepted, then the alarm parameter is set to the values indicated in the following table. This is done to ensure patient safety in the event of an inadvertent value change. You can change these values following the parameter change procedures described above.

High Breath Rate	PIP Low	V_T High	V_T Low	Low SpO2	High Heart Rate	Low Heart Rate
99 BPM	3 cm H ₂ O	2000 ml	0 ml	86%	240 BPM	30 BPM

Alarm Cancellation in Alarm Configuration Menu

There are clinical situations where an alarm occurs, and in the operator's clinical judgment, this alarm should be canceled for the remainder of the unit's operating session. The following constraints apply to alarm cancellation:

1. Only alarms that have occurred in the current operating session can be canceled.
2. Alarms which have not occurred since turn on are indicated with a "--".
3. Canceled alarms are not be saved in the User Settings for the next session.
4. All canceled alarms reappear (if appropriate) when the unit is next turned on. (As an example, the Self Check Fault, calibration due Alarm # 3120, reappears in the next operating session.)

You may cancel the following alarms in the Alarm Configuration Menu:

1. Self Check Fault, calibration due (Alarm #3120)
 2. RTC Battery Fault (Battery Low) (Alarm #3110)
 3. Incomplete Exhalation (Alarm #3110)
 4. PEEP Leak (Alarm #2090)
 5. Fresh Gas Intake Fault (Alarm #3031)
- Patient Inspiratory Demand Not Met (Alarm #3092)

Chapter 5

Alarms

This chapter provides a detailed description and comprehensive reference for the ZOLL Ventilator's alarms and Pop Up Messages. This chapter

- Describes the display format of ZOLL's Smart Help messages in detail.
- Describes alarm types and priorities.
- Provides a comprehensive list of alarms and Pop Up messages.

Alarm Overview

To safeguard the patient, the ZOLL Ventilator continuously monitors the patient, device, and environment to ensure that all of the systems are functioning as intended. When device detects a problem, it triggers an alarm and displays a Smart Help message to alert you.

On the Smart Help message, a multi-line message screen appears in the upper left-hand corner of the display screen. This screen area is the Alarm Message Center (AMC). The AMC displays the alarm name with a series of messages to help you resolve the alarm. The device prioritizes alarms based on the risk to the patient and always presents the alarm with the greatest risk to the patient first. All messages are context-based and suggest what is causing the alarm and how it can be resolved.

The Alarm Message Center (AMC) contains the information and instructions for all active alarms, as in the following example:

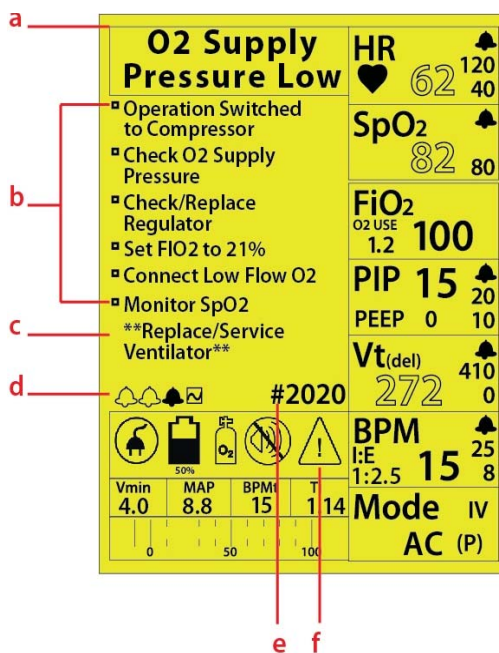

Smart Help Alarm Display

- Alarm Name:** describes the type or cause of the alarm. The Alarm Name appears at the top of the AMC. When more than one alarm occurs at the same time, the device prioritizes the alarms based on the highest risk to the patient.
- Mitigation/Resolution Instructions:** prioritized instructions that describe how to resolve the alarm state.
- If not Resolved Instructions:** Instructions on what to do you cannot resolve the alarm state. The instruction is always shown in the following format ***Message...***.

-
- d. **Alarm Icons:** For each active alarm, an alarm bell appears. When multiple alarms are active, the number of bells corresponds to the number of alarms. The alarm in the AMC is displayed as the solid bell. To view each active alarm, turn the Dial to scroll through all active alarms. The plot icon is also in this list. It allows you to see the current waveform to better assess the nature of the failure. A maximum of six alarms can be displayed without the plot icon.
 - e. **Service Code:** Each alarm has a 4 digit number associated with it, which helps the operator indicate the specific alarm when communicating with technical support. The service codes appear in the following format:
 - 1### High Priority Alarm
 - 2### Medium Priority Alarm
 - 3### High Priority Alarm
 - f. **Attention Warning Icon:** Identifies the severity of the alarm: Low, Medium, or High priority. See the Symbols table in Chapter 1 for the appearance of the warning triangle for each of these three alarms.

Alarm Priorities

Alarm priorities define the operational status of the device and its ability to provide mechanical ventilation. The alarm priorities are as follows:

High Priority

Mechanical ventilation under user control is no longer possible. This alarm priority requires immediate intervention. This includes system failure alarms where the CPU has failed and a backup has taken over to sound the audible and visual alarms. It also includes when the device is turned on and there is no internal or external power source.

Pressing the Mute button has no effect on a high priority alarm. The alarm can only be silenced by turning off the ventilator.

Medium Priority

Mechanical ventilation is active or is possible (maybe for a finite period of time) but, there is a failure or fault with the patient, ventilator circuit, a pneumatic subsystem, or pulse oximeter. This alarm priority requires immediate intervention by the user.

Pressing the Mute button mutes medium priority alarms for 30 seconds. If the alarm trigger still exists after 3 seconds, the audible alarm recurs until you mute it again for another 30 second period or the alarm is resolved.

Low Priority (Advisory)

Safe mechanical ventilation is active but, there is a fault that you must be aware of to ensure safe management of the patient or ventilator. Low priority alarms present with both an audible and yellow LED alarm signal alerting you to the condition. Pressing the Mute button cancels the audible signal. If the alarm is not resolved, the yellow LED remains illuminated to remind you of the fault or failure.

Note: Some Low Priority alarms are canceled and the Alarm LED turns green when you push the Mute button. For others, the audible alarm is canceled but the Alarm LED stay yellow to remind you that the device is operating in a state that needs careful monitoring.

Popup Messages

These alerts appear whenever you attempt to adjust that device in a way that is outside clinical norms or is outside the performance range of the ventilator. Pop Up Messages also appear when you are required to confirm their action before you proceed. For example, if you try to set the low breath rate alarm below 4 that would, practically, disable the alarm. If the desired value is outside the performance range, the Pop Up message alerts you to why cannot make the change. (Example: trying to set the PEEP level greater than the PIP setting).

Muting Alarms

Under most conditions, pressing the Mute button mutes the audible alarm for 30 seconds. As describe in the previous section, pressing the Mute button when a high priority alarm is active does not. Using the ZOLL Ventilator, muting functions as follows:

Preemptive Mute -- to prevent excessive noise in the patient care environment patient, safety alarms, such as *Patient Disconnect*, *PEEP Leak*, and so on, can be preemptively muted for 30 seconds. This enables you to prevent the audible alarm, by pressing the Mute button, before initiating a procedure that could trigger an alarm.

2-Minute Startup Mute -- at start up, the ventilator suspends active patient safety alarms, with the exception of those alarms that could affect the performance of the device. This prevents nuisance alarms during start up while you configure the ventilator. When the Start Menu is used, the 2-minute countdown starts once you select a start option. Once the patient connected, the mute cancels automatically after 15 seconds when there are no active alarms.

Use in High Noise Environments -- in high noise environments, you may be inclined not to mute the alarm while addressing the problem. Not pressing Mute limits the user's ability to resolve the alarm because with each breath the alarm is retriggered and any parameter changes you are attempting are canceled as the alarm retriggers

Alarms Types

The ZOLL Ventilator's alarm types provide a framework for you to see the scope and range of the alarms that the device uses. The alarm types are:

- **Patient Safety** -- Patient Safety Alarms address the ventilation of the patient and their respiratory effort. Pulse oximetry monitoring and circuit/exhalation valve issues are also part of this group.
- **Environment** - Environment Alarms address the device inputs: external power, battery, high pressure O₂ supply, and the fresh gas intake. Ambient and device temperature, barometric pressure, and altitude are also part of this group.
- **Self Check** -- Self Check Alarms address the performance of the device systems and include
 1. Internal Communication (Comm): faults/failures of interdevice communication, cyclic redundancy checking, or processor-related issues
 2. Pneumatic Sensor: faults/failures of the pneumotachographs that measure gas flow or the pressure transducers.
 3. Pneumatic System: faults/failures of the compressor of O₂ supply proportional valve.
 4. Power System: faults/failures of the power system that render the device unable to operate from external power or charge/operate from the internal rechargeable battery.
 5. Pulse Oximeter (Ox) Module: faults/failures of the pulse oximeter module that are not related to monitoring of the patient, a fault or failure of the module.
 6. Preventive Maintenance: alarms that occur when device is due for preventive maintenance.

Alarm Groups

The following table displays the ZOLL Ventilator's Alarm Groups:

	Alarm Groups	
Patient Safety	Environment	Self Check
Airway Pressure -- High/Low	Battery -- Battery Drained -- Battery Nearly Drained -- Battery Low -- Discharge Fault -- Too Hot/Cold	Ambient Pressure -- High/Low
Apnea	External Power -- Current High -- DC Power Reversed -- High -- Low/Disconnect	Firmware Mismatch
AutoPEEP	Gas Intake -- Blocked -- Restricted	Internal Comm -- Fault/Failures
Breath Rate (BPM) -- High/Low	O2 Supply -- High/Low - Disconnect	Pneumatic Sensor -- Airway -- Autocal -- Pneumotach -- Transducer
Exhalation -- Fault/Failure		Pneumatic System -- Compressor -- O2 Valve
Heart Rate (HR) -- High/Low		Power Cycle Needed
Inspiratory Demand		Preventive Maintenance
Insufficient Flow		Pulse Oximeter -- Comm Failure -- Module Failure
Patient Detected		Temperature -- High/Low -- Sensor Failure
PEEP Leak		

	Alarm Groups	
SpO2 -- Low -- Disconnect -- Defective Sensor -- Not Connected -- Invalid Sensor -- Light Contamination -- Low Perfusion -- Search		
Tidal Volume -- High/Low		
Tubing Compliance		

High Priority Alarms

Service Code	Alarm Name/Mitigation/Resolution
1001	<p>Self Check Failure</p> <p>Alarm triggers when the compressor fails to operate or fails to provide the flow required to deliver a breath and high pressure O₂ is not available to provide ventilation.</p> <p><i>Mitigation/Info: Pneumatic System: Compressor, Manually Ventilate Patient, Connect 55 psig/380 kPa O₂, Restart Ventilator with O₂, **Contact Service Center**</i></p>
1002	<p>Self Check Failure</p> <p>Alarm triggers when communication between the compressor controller and Smart Pneumatic Module (SPM) is lost and high pressure O₂ is not available to provide ventilation.</p> <p><i>Mitigation/Info: Pneumatic System: Compressor, Manually Ventilate Patient, Connect 55</i></p>
1003	<p>Self Check Failure</p> <p>Alarm triggers when the flow from the first breath is $\pm 20\%$ of the expected flow for the tidal volume at start up. This unusually low RPM is a symptom of a dirty flow screen which cannot be serviced by the user.</p> <p><i>Mitigation/Info: Pneumatic Sensor: Pneumotach, Manually Ventilate Patient, **Contact Service Center**</i></p>
1010	<p>Self Check Failure</p> <p>Alarm triggers when the O₂ valve fails in the open position which results in continuous inspiratory flow. When this occurs the device automatically opens the exhalation valve to prevent pressure from accumulating in the circuit and ventilation stops.</p> <p><i>Mitigation/Info: Pneumatic System: O₂ Valve, Manually Ventilate Patient, **Contact Service Center**</i></p>
1011	<p>Self Check Failure</p> <p>Alarm occurs when the signal to the O₂ valve is not delivering the required flow rate and the compressor is not available to provide ventilation.</p> <p><i>Mitigation/Info: Pneumatic System: O₂ Valve, Manually Ventilate Patient, **Contact Service Center**</i></p>
1012	<p>Self Check Failure</p> <p>Alarm occurs when the communication between the O₂ valve and the SPM fails and the compressor is not available to provide ventilation.</p> <p><i>Mitigation/Info: Pneumatic System: O₂ Valve, Manually Ventilate Patient, **Contact Service Center**</i></p>
1020	<p>Low O₂ Supply Failure</p> <p>Alarm occurs when the O₂ supply pressure is <35 psig (241 kPa) and the compressor is not available to support ventilation. If the O₂ source can be restored the device should be cycled off then on to reset. By design the device will not reestablish O₂ operation unless the supply pressure is ≥ 40 psig (276 kPa). If the supply pressure is between 40 and 87 psig (276 to 600 kPa) the user should check the hose connections for leaks. Occasionally, this alarm can be caused by a regulator that provides a static pressure within range but is not able to provide the flow necessary to meet the patient flow demand.</p> <p><i>Mitigation/Info: Manually Ventilate Patient, Connect 55 psig/380 kPa O₂, Restart, Check O₂ Supply for</i></p>

1030	<p>Gas Intake Failure</p> <p>Alarm occurs when the Fresh Gas/Emergency Air Inlet is blocked so that the compressor is not able to deliver flow sufficient for the current settings and high pressure O₂ is not available to support ventilation. The user should clear the blockage and restart the ventilator. A false alarm can be triggered in very high vibration environments.</p> <p><i>Mitigation/Info: Manually Ventilate Patient, Clear Blocked Intake, Connect 55 psig/380 kPa O₂, Restart Vent-</i></p>
1041	<p>High O₂ Supply Failure</p> <p>Alarm triggers when the O₂ supply pressure is >87 psig (600 kPa). Pressures above 87 psig (600 kPa) can result in a catastrophic failure, harm to the patient and/or damage to the device. While the patient is manually ventilated the user or assistant should seek to reduce the O₂ supply pressure. Sometimes this requires changing the regulator which is not functioning as required. If the pressure cannot be reduced and a low flow device like a flow meter is available the user can provide supplemental O₂ via the optional low flow O₂ reservoir. To clear the alarm the device should be turned off and then restarted with supply pressure in the appropriate range (40 to 87 psig, 276 to 600 kPa) or without the high pressure O₂ source connected.</p>
1051	<p>Self Check Failure</p> <p>Alarm triggers when the autocal procedure is not able to zero the airway pressure transducer to ambient pressure. When this occurs, manually ventilate the patient, replace the ventilator replaced and contact the service center for additional information. Note: a false alarm can be triggered during operation in very high vibration environments when the device is not mounted correctly. If this could be the cause, restart the ventilator and continue operation if no alarms are triggered.</p> <p><i>Mitigation/Info: Pneumatic Sensor: Autocal, Manually Ventilate Patient, **Contact Service Center**</i></p>
1052	<p>Self Check Failure</p> <p>Communication between the airway pressure sensor and SPM is lost. When this happens, manually ventilate the patient, replace the ventilator and contact the service center for additional information. <i>Mitigation/Info: Pneumatic Sensor: Airway Pressure, Manually Ventilate Patient, **Contact Service Center**</i></p>
1060	<p>Exhalation System Failure</p> <p>Alarm occurs when the PIP fails to return to the baseline pressure for 3 consecutive breaths, indicating that the exhalation control valve has failed. When triggered, the device stops ventilating and attempts to discharge the pressure in the breathing circuit to atmosphere. This failure may be caused by a significant blockage of the exhalation valve or an occlusion/kink in the exhalation valve tube. If possible, the user should replace the breathing circuit and restart the ventilator. If this does not resolve the failure, replace the ventilator and contact the service center for additional information.</p> <p><i>Mitigation/Info: Patient Can Not Exhale, Manually Ventilate Patient, Check for Kinked Hose/Tube, Replace</i></p>
1061	<p>Exhalation System Failure</p> <p>The airway pressure, PIP, is >40 cm H₂O, the PIP High Limit (when PIP High Limit is < 35 cm H₂O) for > 5 seconds, or when the PIP is >75 cm H₂O for > 1.5 seconds. When this happens, the device stops ventilating and attempts to discharge the pressure in the breathing circuit to atmosphere. This failure may be caused by a significant blockage of the exhalation valve or an occlusion/kink in the exhalation valve tube. If possible, the user should replace the breathing circuit and restart the ventilator. If this does not resolve the problem, replace the ventilator and contact the service center for additional information.</p> <p><i>Mitigation/Info: Patient Can Not Exhale, Manually Ventilate Patient, Check for Kinked Hose/Tube, Replace</i></p>
1172	<p>Self Check Failure</p> <p>Alarm occurs when the 5 volt power bus fails to provide the required voltage. If this failure occurs, the user should manually ventilate the patient, replace the ventilator and contact the service center for additional information.</p> <p><i>Mitigation/Info: Pneumatic Sensor: Autocal, Manually Ventilate Patient, **Contact Service Center**</i></p>

1173	<p>Self Check Failure</p> <p>Alarm occurs when communication fails between one of the subcomponents and the host processor. If this failure occurs, the user should manually ventilate the patient, replace the ventilator and contact the service center for additional information.</p> <p><i>Mitigation/Info: Internal COMM, Manually Ventilate Patient, Backup Ventilator Started, **Contact Service</i></p>
1174	<p>Self Check Failure</p> <p>Alarm occurs when the device is not able to calibrate the one or more transducers and is no longer able to operate safely. If this failure occurs, the user should manually ventilate the patient, replace the ventilator and contact the service center for additional information.</p> <p><i>Mitigation/Info: Pneumatic Sensor: Transducer, Manually Ventilate Patient, Restart Ventilator, **Contact Service Center**</i></p>
1175	<p>Self Check Failure</p> <p>Alarm triggers when the internal communication bus and the host are not able to communicate with the sub-assemblies. If this failure occurs, the user should manually ventilate the patient, replace the ventilator and contact the service center for additional information.</p> <p><i>Mitigation/Info: Internal COMM, Manually Ventilate Patient, **Contact Service Center**</i></p>
1176	<p>Self Check Failure</p> <p>Alarm triggers when the calibration file fails its integrity check. The user should manually ventilate the patient, replace the ventilator and contact the service center for additional information.</p> <p><i>Mitigation/Info: Internal COMM, Manually Ventilate Patient, **Contact Service Center**</i></p>
1420	<p>Self Check: Complete Power Failure</p> <p>Alarm triggers when power is lost from both the internal battery and an external source during operation. When this occurs, the LCD blanks (no power for operation), the audible alarm pulses rapidly, and the visual alarm flashes rapidly. This alarm will last approximately two minutes. If the device can be recharged after the failure and there are no other issues it can be returned to service. If there are any questions, contact the service center for additional information.</p>
1430	<p>Drained Battery</p> <p>Alarm triggers when the internal battery power drops below the amount required to provide ventilation and external power is not connected. When this occurs there is enough power to operate the user interface and provide information to the user. The user should be manually ventilate the patient while an external source of power is sought. To cancel the alarm and begin operation with external power the device must be turned off and then back on.</p> <p><i>Mitigation/Info: Manually Ventilate Patient, Connect External Power, **Contact Service Center**</i></p>
1471	<p>Self Check Failure</p> <p>Alarm triggers when the device is no longer able to communicate with the User Interface Module (UIM) and the interface controls. When this occurs ventilation continues at the current settings or the backup mode settings and the high priority alarm sounds. The user should manually ventilate the patient, replace the ventilator and contact the service center for additional information.</p> <p><i>Mitigation/Info: Internal COMM, Manually Ventilate Patient, **Contact Service Center**</i></p>
1472	<p>Self Check Failure</p> <p>Alarm triggers when the device is no longer able to communicate with the Smart Pneumatic Module (SPM). When this occurs ventilation continues at the current settings or the backup mode settings and the high priority alarm sounds. The user should manually ventilate the patient, replace the ventilator and contact the service center for additional information.</p> <p><i>Mitigation/Info: Internal COMM, Manually Ventilate Patient, **Contact Service Center**</i></p>

1473	<p>Self Check Failure</p> <p>Alarm triggers when no valid data is sent from the SPM within 1 second. When this occurs ventilation continues at the current settings or the backup mode settings and the high priority alarm sounds. The user should manually ventilate the patient, replace the ventilator and contact the service center for additional information.</p> <p><i>Mitigation/Info: Internal COMM, Manually Ventilate Patient, **Contact Service Center**</i></p>
1474	<p>Self Check Failure</p> <p>Alarm triggers when cyclic redundancy checking between the device and SPM fails. When this occurs ventilation continues at the current setting or the backup mode settings and the high priority alarm sounds. The user should manually ventilate the patient, replace the ventilator and contact the service center for additional information.</p> <p><i>Mitigation/Info: Internal COMM, Manually Ventilate Patient, **Contact Service Center**</i></p>
1475	<p>Self Check Failure</p> <p>Alarm triggers when the device has lost communication with the contrast control and in most instances the content of the LCD is not visible. When this occurs ventilation continues at the current settings or the backup mode setting and the high priority alarm sounds. The user should manually ventilate the patient, replace the ventilator and contact the service center for additional information.</p> <p><i>Mitigation/Info: Internal COMM, Manually Ventilate Patient, Backup Ventilator Started, **Contact Service Center**</i></p>
1480	<p>Self Check Failure</p> <p>Alarm triggers when the device and SPM software loads are not compatible. This alarm is typically associated with an SPM change where the technician failed to update the device and SPM to the current software revision. Ventilation is provided using the backup mode settings. The user should manually ventilate the patient, replace the ventilator and contact the service center for additional information.</p> <p><i>Mitigation/Info: Firmware Mismatch, Manually Ventilate Patient, Software Compatibility Failure, **Contact Service Center**</i></p>

Medium Priority Alarms

2001	<p>Self Check Fault</p> <p>Alarm triggers when the communication between the compressor and the SPM fails and high pressure O₂ is available to provide ventilation. The alarm will continue to sound as a medium priority alarm until the user acknowledges that ventilation is being provided using O₂ by setting the FIO₂ to 100%. At this time the priority changes to low priority. While operating in this state the user should ensure an adequate supply of O₂. Failure to maintain the O₂ supply will result in a high priority alarm.</p> <p><i>Mitigation/Info: Pneumatic System: Compressor, Operation Switched to O2 Supply, Set FIO2 to 100%, Moni-</i></p>
2002	<p>Self Check Fault</p> <p>Alarm triggers when the communication between the O₂ valve and the SPM fails and the compressor is available to provide ventilation. The alarm will continue to sound as a medium priority alarm until the user acknowledges that ventilation is being provided using the compressor by setting the FIO₂ to 21%. At this time the alarm priority changes to low. While operating in this state the user should monitor the SpO₂ to ensure that adequate oxygenation is maintained. If low flow O₂ is available it can be entrained through the Fresh Gas/Emergency Air Intake port using the optional O₂ reservoir. Maintain an acceptable SpO₂ by adjusting the O₂ supply up or down to increase or decrease the amount of O₂ delivered to the patient.</p> <p><i>Mitigation/Info: Pneumatic System: Compressor, Operation Switched to O2 Supply, Set FIO2 to 100%, Moni-</i></p>
2011	<p>Self Check Fault</p> <p>Alarm triggers when the signal to the O₂ valve is outside of the calibration range for the required flow rate and the compressor is available to provide ventilation. The medium priority alarm will continue until the user acknowledges that ventilation is being provided using the compressor by setting the FIO₂ to 21%. At this time the alarm priority changes to low priority. While operating in this state the user should monitor the SpO₂ to ensure that adequate oxygenation is maintained. If low flow O₂ is available it can be entrained through the Fresh Gas/Emergency Air Intake port using the optional O₂ reservoir. Maintain an acceptable SpO₂ by adjusting the O₂ supply up or down to increase or decrease the amount of O₂ delivered to the patient.</p> <p><i>Mitigation: Pneumatic System: O2 Valve, Operation Switched to Compressor, Connect Low Flow O2, Monitor</i></p>
2012	<p>Self Check Fault</p> <p>Alarm triggers when the communication between the O₂ valve and the SPM fails and the compressor is available to provide ventilation. The alarm will continue to sound as a medium priority alarm until the user acknowledges that ventilation is being provided using the compressor by setting the FIO₂ to 21%. At this time the alarm priority changes to low. While operating in this state the user should monitor the SpO₂ to ensure that adequate oxygenation is maintained. If low flow O₂ is available it can be entrained through the Fresh Gas/Emergency Air Intake port using the optional O₂ reservoir. Maintain an acceptable SpO₂ by adjusting the O₂ supply up or down to increase or decrease the amount of O₂ delivered to the patient.</p> <p><i>Mitigation/Info: Pneumatic System O2 Valve, Set FIO2 To 21%, Connect Low Flow O2, Monitor SpO2</i></p>

2020	<p>Low O₂ Supply Fault</p> <p>Alarm triggers when the O₂ supply pressure is <35 psig (241 kPa) and the compressor is able to support ventilation. When this occurs the device begins ventilation using the compressor. The alarm will continue to sound as a medium priority alarm until the user acknowledges that ventilation is being provided using the compressor by setting the FIO₂ to 21%. The alarm will cancel completely when the user sets to 21%. NOTE: The device works with or without external O₂. If O₂ is connected the device will not continue O₂ operation unless the supply pressure is ≥40 psig (276 kPa). This is done to prevent continuous cycling between alarms during the inspiratory phase and no alarm during the expiratory phases. If low flow O₂ is available it can be entrained through the Fresh Gas/Emergency Air Intake port using the optional O₂ reservoir. Maintain an acceptable SpO₂ by adjusting the O₂ supply up or down to increase or decrease the amount of O₂ delivered to the patient.</p>
2030	<p>Gas Intake Fault</p> <p>Alarm triggers when the Fresh Gas/Emergency Air Inlet is blocked so that the compressor is not able to deliver a breath within ±10% of the current settings and high pressure O₂ is available to support ventilation. When this occurs the ventilator immediately switches to O₂ powered ventilation. To clear the alarm first set the FIO₂ to 100% to acknowledge that the patient is being ventilated at 100%, clear the blockage and then set the FIO₂ back to the original value. Once the blockage has been cleared operation with the compressor will restart. If the blockage cannot be cleared, the alarm will resound, continue ventilation with FIO₂ set to 100% and ensure an adequate supply of O₂. NOTE: A high vibration environment can trigger this alarm. If necessary, the user can activate the O₂ Reservoir Mode while continuing to operate normally. This will suppress the alarm.</p>
2053	<p>Self Check Fault</p> <p>Alarm triggers when the expiratory time is <170 ms for 3 consecutive breaths. When this occurs the device attempts to reestablish a baseline by momentarily setting PEEP to 0 cm H₂O and suspending triggered breaths. This interruption lasts no longer than 2 breath cycles. The user should also check for leaks in the hose and tubes, patient airway and exhalation valve. If recalibration is successful the alarm will automatically cancel. If the device does not reset, manually ventilated the patient, replace the ventilator and contact the service center for additional information.</p> <p><i>Mitigation/Info: Pneumatic Sensor: Airway Pressure, Check Circuit for Leaks/Disconnects, , Check Tube</i></p>
2062	<p>Exhalation System Fault</p> <p>Alarm triggers when the airway pressure, PIP, measured at the end of expiration is >5 cm H₂O above the baseline pressure, PEEP. This is typically caused by a restriction of the exhalation valve or an occlusion/kink in one or more of the breathing circuit tubes or hose. If the breathing circuit tubes appear to be intact the circuit should be replaced to eliminate the possibility of a bad exhalation valve. If the condition does not resolve the user should manually ventilate the patient, replace the ventilator and contact the service center for additional information.</p> <p><i>Mitigation/Info: Check Patient Exhalation, Check Circuit for Kinked Hose/Tube, Check for Blocked Exhalation</i></p>
2070	<p>Airway Pressure High</p> <p>Alarm triggers when the airway pressure, PIP, is > the high airway pressure limit for 2 consecutive breaths. When the limit is reached, the flow decelerates to keep the PIP below the airway pressure for the duration of the breath (inspiratory time). The user should check for kinks or blockage of the breathing circuit, exhalation valve or patient airway. In some instances the cause can be an accumulation of secretions in the airway which will require suctioning to clear. The user should also assess if the patient is fighting the ventilator, asynchrony, or if the high airway pressure limit is set too low.</p> <p><i>Mitigation/Info: Pressure Exceeds Limit Setting, Check Circuit for Kinked Hose/Tube, Check for Airway</i></p>

2071	<p>Low Airway Pressure</p> <p>Alarm triggers when the airway pressure, PIP, is < the low airway pressure limit for 2 consecutive breaths. The user should check for leaks/disconnects in the breathing circuit, patient airway or a failure of the exhalation valve. The user should also assess if the patient is breathing with the ventilator, the PIP or tidal volume are set too low, or if the low airway pressure limit is set too high. If a replacement is available the user should replace the breathing circuit. If these mitigations do not resolve the alarm condition, replace the ventilator and contact the service center for more information.</p> <p><i>Mitigation/Info: Check Patient Connection, Check Circuit For Loose Hose/Tube, Check Exhalation Valve,</i></p>
2072	<p>High Tidal Volume</p> <p>Alarm triggers during pressure targeted ventilation when the delivered tidal volume exceeds the user defined limit for 2 consecutive breaths. This can be caused by a leak in the patient connection or breathing circuit. When the ventilator is not able to reach the pressure target flow increases to compensate which leads to a high delivered tidal volume. It is critical to set this alarm with infant and pediatric patients given that the high resistance airways used with these patients can provide a false airway pressure even when the patient has extubated or decannulated. The user should check for leaks/disconnects in the breathing circuit, patient airway or a failure of the exhalation valve. Users should also assess if the patient is anxious and breathing deeply or if the high tidal volume limit is set too low. If a replacement is available the user should replace the breathing circuit.</p> <p><i>Mitigation/Info: Check Patient Connection, Check Circuit For Loose Hose/Tube, Check Exhalation Valve,</i></p>
2073	<p>Low Tidal Volume</p> <p>Alarm triggers during pressure targeted ventilation when the delivered tidal volume does not reach the user defined limit for 2 consecutive breaths. When this occurs flow decelerates to maintain the airway pressure at airway pressure limit for the duration of the breath (inspiratory time). If the PIP setting is set properly the breath should be greater than the low limit, provided it is set correctly. The user should check for kinks or blockage of the breathing circuit or patient airway. In some instances the cause can be an accumulation of secretions in the airway which will require suctioning to clear. The user should also assess if the patient is fighting the ventilator, asynchrony, or if the PIP target is set too low.</p> <p><i>Mitigation/Info: Check Circuit For Kinked Hose/Tube, Check For Airway Obstruction, Suction Airway If Nec-</i></p>
2074	<p>High Breath Rate</p> <p>Alarm triggers when the actual breathing rate (set rate plus spontaneous patient rate) exceeds the high alarm limit. This can be caused by the patient breathing too fast due to anxiety or pending respiratory failure. It can also be caused by autotriggering due to a leak or the when the spontaneous/assisted breath trigger is set too close to the baseline pressure, PEEP. The user should check for leaks/disconnects in the breathing circuit, patient airway or a failure of the exhalation valve. The user should also assess if the patient is anxious and breathing deeply or if the high tidal volume limit is set too low. If a replacement is available the user should replace the breathing circuit.</p> <p><i>Mitigation/Info: Check For Loose Circuit Connection, Check Trigger Setting, Check High Alarm Limit Setting,</i></p>
2075	<p>Low Breath Rate/Apnea</p> <p>Alarm triggers when the actual breathing rate (set rate plus spontaneous patient rate) is less than the low alarm limit. This can be caused by the patient not breathing or breathing at a rate less than the limit. If the spontaneous/assisted breath trigger is not sensitive enough the patient may not be able to trigger breaths. The user should also determine if the low rate is set too high for the patient.</p> <p><i>Mitigation/Info: Check Patient for Spontaneous Breathing, Adjust Breath Trigger, Check Low Alarm Limit Setting, Increase Ventilation Support, ** Manually Ventilate Patient**</i></p>
2076	<p>Apnea</p> <p>Alarm triggers when the spontaneous breathing rate is less than the low alarm limit. This alarm only occurs in noninvasive ventilation, CPAP and BL modes. The alarm can be caused by the patient not breathing or breathing at a rate less than the limit. The apnea backup ventilation starts automatically when the alarm is triggered. The user should select and active mode of ventilation, AC or SIMV, to support the patient.</p> <p><i>Mitigation/Info: Apnea Backup Ventilation Started, Set Mode to AC or SIMV, Set Rate and Tidal Volume/ Pressure Target, ** Manually Ventilate Patient**</i></p>

2090	<p>PEEP Leak</p> <p>Alarm triggers when the airway pressure drops below the PEEP setting by 2 cm H₂O during the expiratory phase of the breath. This can be caused by a leak in the breathing circuit, exhalation valve or patient airway. The user should check the breathing circuit and exhalation valve to ensure that all connections are tight. If the circuit appears damaged or is suspect it should be replaced. The user should also check if there is a cuff leak from the patient's airway or mask. If these mitigations do not resolve the alarm the user can choose to use leak compensation to provide additional flow during the expiratory phase to compensate for the leak. If you still cannot compensate for the leak, consult the attending physician. If this fails replace the ventilator and contact the service center for more information.</p>
2095	<p>Insufficient Flow</p> <p>Alarm triggers when the pressure target is not reached during the inspiratory period during pressure targeted ventilation. Typically this can occur when the Rise Time is set too low for the patient and their respiratory mechanics. Decrease the Rise Time and check the circuit and exhalation valve for leaks or disconnects. If the flow cannot be adjusted appropriately then the patient should be ventilated using volume targeted ventilation.</p> <p><i>Mitigation/Info: Pressure Target Not Met, Decrease Rise Time , Press/Hold BPM Button, Consult Physician, ** Ventilate With Volume Target**</i></p>
2100	<p>Patient Disconnect</p> <p>Alarm triggers when the airway pressure fails to exceed the PEEP setting by ~7 cm H₂O. When this occurs the user should quickly check the patient connection, breathing circuit connections and the exhalation valve. At times this alarm can be caused by the patient breathing with the ventilator during inspiration which prevents the PIP from passing the minimum pressure. While resolving the alarm condition the user should be sure to manually ventilate the patient.</p> <p><i>Mitigation/Info: Check Patient Connection, Check Circuit for Loose Hose/Tube, Check Exhalation Valve, Check Patient, Replace Circuit, **Manually Ventilate Patient**</i></p>
2110	<p>Patient Detected</p> <p>An alarm triggers when you connect the patient to the ventilator while the Start Menu is still active. To resolve the alarm, you must select a mode of ventilation and configure the device appropriately for the patient. In addition, you should perform the Operational Test procedure before reconnecting the patient to the device.</p> <p><i>Mitigation/Info: Backup Ventilation Started, Set Mode (AC, SIMV, CPAP, BL), Configure Other Settings, **Manually Ventilate Patient and Restart**</i></p>
2170	<p>Spont. Breath PIP High</p> <p>Alarm triggers when the airway pressure, PIP, exceeds the High PIP Limit Setting during 2 consecutive spontaneous breaths. The user should quickly check for kinked hoses/ tubes and check for airway obstruction. Suctioned the patient if necessary. The user should also check if the High PIP limit is set correctly or if the pressure support (PS) level is set too high. While resolving the alarm condition the user should be sure to manually ventilate the patient.</p> <p><i>Mitigation/Info: Pressure Exceeds Limit Setting, Check Circuit for Kinked Hose/Tube, Check for Airway Obstruction, Suction Airway if Necessary, Check High Limit Setting, **Manually Ventilate Patient**</i></p>
2171	<p>Spont. Breath PIP Low</p> <p>Alarm triggers when the airway pressure, PIP, exceeds the Low PIP Limit Setting during 2 consecutive spontaneous breaths. The user should quickly check circuit for loose hoses/ tubes and also check the exhalation valve and the tube placement/ cuff. The user should also check if the Low PIP Limit is set correctly. While resolving the alarm condition the user should be sure to manually ventilate the patient.</p> <p><i>Mitigation/Info: Check Patient Connection, Check Circuit for Loose Hose/Tube, Check Exhalation Valve, Check Tube Placement/ Cuff, Check Low Limit Setting, **Manually Ventilate Patient**</i></p>

2172	<p>Spont. Breath Vt High</p> <p>Alarm triggers when the high VT Limit is exceeded during 2 consecutive spontaneous breaths. The user should check: the patient connection, airway placement, breathing circuit for loose hoses/ tubes and also check the exhalation valve. The user should also check if the High VT Limit is set correctly. While resolving the alarm condition the user should be sure to manually ventilate the patient.</p> <p><i>Mitigation/Info: Check Patient Connection, Check Circuit for Loose Hose/Tube, Check Exhalation Valve, Check Tube Placement/ Cuff, Check Limit Setting, **Monitor Patient**</i></p>
2173	<p>Spont. Breath Tt Low</p> <p>Alarm triggers when the Low VT Limit Setting is not achieved during 2 consecutive spontaneous breaths. When this occurs, the user should quickly check for kinked hoses/ tubes and check for airway obstruction. The patient should be suctioned if necessary. The user should also check if the Low VT limit is set correctly. While resolving the alarm condition the user should be sure to manually ventilate the patient.</p> <p><i>Mitigation/Info: Check Circuit for Kinked Hose/Tube, Check for Airway Obstruction, Suction Airway if Necessary, Check Low Limit Setting, **Manually Ventilate Patient**</i></p>
2300	<p>Self Check Fault</p> <p>Alarm triggers when the pulse oximeter module fails while in use. The user cannot resolve the fault. When the alarm is active "-- --" displays in the HR and SpO₂ windows. Pressing the Mute/Cancel button silences the audible alarm for 30 seconds. To resolve the alarm, remove the probe from the device and put the pulse oximeter in standby "stby". Contact the service center for additional information.</p> <p><i>Mitigation/Info: Pulse Ox Module, Internal Failure, SpO2/HR Not Available from Pulse Ox, Turn Off Pulse Ox,</i></p>
2301	<p>Self Check Fault</p> <p>Alarm triggers when the communication between the pulse oximeter module and device fails. When this occurs the user must turn off the pulse oximeter monitor to end the alarm condition through the SpO₂ Context menu while also removing the probe from the device. When this is done "stby" appears in the parameter windows for SpO₂ and HR as those parameters are no longer available. When appropriate the user should replace the ventilator and contact the service center for additional information.</p> <p><i>Mitigation/Info: Internal COMM: Pulse Ox Module, SpO2/HR Not Available from Pulse Ox, Turn Off Pulse Ox, Remove SpO2 Cable from Ventilator, **Contact Service Center**</i></p>
2314	<p>Pulse Ox Sensor Off Patient</p> <p>Alarm triggers when an operating sensor loses the patient signal. The most common cause is when the sensor disconnects from the patient or is misaligned with the sensor site. This alarm can also be caused by poor perfusion at the sensor site which doesn't provide an adequate signal. In these cases try another site. Replace the sensor if another sensor is available. If the alarm condition cannot be resolved the user should remove the sensor from the patient and put the pulse oximetry monitor in standby "stby".</p> <p><i>Mitigation/Info: Check Pulse Ox Sensor Site, Check Patient for Peripheral Pulse, Change Placement, Check Sensor Operation, Replace Sensor, **Turn Off Pulse Ox Monitoring**</i></p>
2401	<p>SpO2 Low</p> <p>Alarm triggers whenever the SpO₂ value drops below the Low SpO₂ Limit. The default value for the limit is 94%. Corrective actions are increasing oxygenation by increasing the FIO₂ or PEEP settings. PEEP should only be changed based on consultation with the attending physician. When using low flow O₂ the user should increase the flow of O₂ to the low flow O₂ reservoir.</p> <p><i>Mitigation/Info: SpO2 Below Limit, Increase FIO2, Check O2 Supply, Increase PEEP Per Physician, **Con-</i></p>
2410	<p>Heart Rate High</p> <p>Alarm triggers when the heart rate is greater than the High Heart Rate Limit. The default value for the limit is 120 beats/minute. The user should consult with the attending physician on how best to reduce the heart rate to an acceptable level.</p> <p><i>Mitigation/Info: Heart Rate Above Limit, Check High Limit Setting, **Consult Physician**</i></p>

2411	<p>Heart Rate Low</p> <p>Alarm triggers when the heart rate is less than the Low Heart Rate Limit. The default value for the limit is 40 beats/minute. The user should consult with the attending physician on how best to increase the heart rate to an acceptable level.</p> <p><i>Mitigation/Info: Heart Rate Below Limit, Check Low Limit Setting, **Consult Physician**</i></p>
2421	<p>Self Check Fault</p> <p>Alarm triggers when there is a failure of the input protection circuit and the device is able to operate. The alarm will continue until the device is turned off. The user can mute the alarm for 30 seconds by pushing the MUTE/CANCEL button. The user should replace the ventilator and contact the service center for additional information.</p> <p><i>Mitigation/Info: Power System, Power System Needs Repair, Internal Battery Operation, Monitor Battery % Charge, **Contact Service Center**</i></p>
2423	<p>Self Check Fault</p> <p>Alarm triggers when the internal power circuit has failed and external power is connected but cannot be used. The fault cannot be repaired by the user. Pressing the Mute/Cancel button silences the audible alarm for 30 seconds. Replace the ventilator and contact the service center for additional information.</p> <p><i>Mitigation/Info: Power System, Power System Needs Repair, Internal Battery Operation, Monitor Battery % Charge, **Contact Service Center**</i></p>
2430	<p>Nearly Drained Battery</p> <p>Alarm triggers when the device detects that there is ≤5 minutes of battery operation remaining and external power is not connected. The user should immediately seek a source of external power and/or plan to provide manual ventilation. Attaching external power will immediately clear the alarm though a low priority alarm will remain until the internal battery has recharged so that the device can provide 30 minutes of operating time. This will take approximately 5 to 10 minutes. If recharging the battery does not resolve the issue, contact the service center for additional information.</p> <p><i>Mitigation/Info: <5 Minutes Operation, Connect External Power, Ensure Ability to Manually Ventilate, ** Con-</i></p>
2450	<p>Battery Discharge Fault</p> <p>Alarm triggers when the battery temperature reaches 70 °C (158 °F) which is 5 °C from its maximum operating temperature using the internal battery and external power is not connected. When the battery temperature reaches 75 °C (167 °F) the battery will shut down to prevent failure and the device will sound a high priority alarm and shutdown. If possible the user should provide a source of external power which will allow operation to continue at the current and higher temperatures. In addition, the device should be removed from the soft case which acts as insulation. Shading the patient and ventilator from direct sunlight may also help reduce the battery temperature.</p> <p><i>Mitigation/Info: Battery Within 5 °C of High Limit, Remove Padded Case, Ensure External Power Available, Ensure Ability to Manually Ventilate, **Move To Cooler Location**</i></p>
2455	<p>Battery Fault</p> <p>Alarm triggers when the device is not able to communicate with the internal battery. When this occurs the device does not know the current charge of the battery and operation could stop at any time. To continue operation and the user should connect external power and ensure the ability to manually ventilate the patient. When external power is connected the alarm priority decreases to Low Priority, replace the ventilator and contact the service center.</p> <p><i>Mitigation/Info: Battery Communication, Connect External Power, Ensure Ability to Manually Ventilate Patient, **Contact Service Center**</i></p>

Low Priority Alarms

Service Code	Alarm Name/Mitigation/Resolution
3001	<p>Self Check Fault</p> <p>Alarm triggers when the compressor fails to operate or fails to provide the flow required to deliver a breath within $\pm 10\%$ of the current settings, high pressure O₂ is available to provide ventilation and the user has set the FIO₂ to 100%. While operating in this state the user should ensure an adequate supply of O₂. Failure to maintain the O₂ supply will result in a high priority alarm. The user cannot repair the compressor, replace the ventilator and contact the service center for additional information.</p> <p><i>Mitigation: Pneumatic System Compressor, Ensure 55 psig/380 kPa O₂, O₂ Operation Only, **Contact</i></p>
3002	<p>Self Check Fault</p> <p>Alarm triggers when communication between the compressor controller and SPM is lost, high pressure O₂ is available to provide ventilation and the user has set the FIO₂ to 100%. While operating in this state the user should ensure an adequate supply of O₂. Failure to maintain the O₂ supply will result in a high priority alarm. The user cannot repair the device, replace the ventilator and contact the service center for additional information.</p> <p><i>Mitigation: Pneumatic System: Compressor, Ensure 55 psig.380 kPa O₂ Supply, O₂ Operation Only, **Contact Service Center**</i></p>
3011	<p>Self Check Fault</p> <p>Alarm triggers when the signal to the O₂ valve is outside of the calibration range for the required flow rate, the compressor is available to provide ventilation and the user has acknowledged that ventilation is being provided using the compressor by setting the FIO₂ to 21%. While operating in this state the user should monitor the SpO₂ to ensure that adequate oxygenation is maintained. If low flow O₂ is available it can be entrained through the Fresh Gas/Emergency Air Inlet port using the optional O₂ reservoir. Maintain an acceptable SpO₂ by adjusting the O₂ supply up or down to increase or decrease the amount of O₂ delivered to the patient. The user cannot repair the O₂ valve, replace the ventilator and contact the service center for additional information.</p>
3012	<p>Self Check Fault</p> <p>Alarm triggers when communication between the O₂ valve and SPM is lost, the compressor is available to provide ventilation and the user has set the FIO₂ to 21%. While operating in this state the user should monitor the SpO₂ to ensure that adequate oxygenation is maintained. If low flow O₂ is available it can be entrained through the Fresh Gas/Emergency Air Inlet port using the optional O₂ reservoir. Maintain an acceptable SpO₂ by adjusting the O₂ supply up or down to increase or decrease the amount of O₂ delivered to the patient. The user cannot repair the O₂ valve, replace the ventilator and contact the service center for additional information.</p> <p><i>Mitigation/Info: Pneumatic System: O₂ Valve, Compressor Operation Only!, Keep FIO₂ at 21%, Con-</i></p>

3030	<p>Gas Intake Fault</p> <p>Alarm triggers when the Fresh Gas/Emergency Air Inlet is blocked so that the compressor is not able to deliver breaths within $\pm 10\%$ of the current settings, high pressure O₂ is available to support ventilation and the user has set the FIO₂ to 100%. To clear the alarm, clear the blockage and set the FIO₂ back to the original value. If the blockage is cleared operation with the compressor will restart. If the blockage is not cleared, the alarm will resound, set the FIO₂ to 100%, continue ventilation and ensure an adequate supply of O₂. It is possible for this alarm to be a false alarm that is triggered in a very high vibration environment or if the device is not mounted correctly. If the alarm does not resolve contact the service center for additional information.</p> <p><i>Mitigation/Info: O2 Supply Operation, Clear Blocked Intake, Reset FIO2 to Previous, Monitor SpO2, **Con-</i></p>
3031	<p>Intake Restricted</p> <p>Alarm triggers when the Fresh Gas/Emergency Air Inlet is blocked but is still capable of delivering breaths within $\pm 10\%$ of the current settings. This could be caused by an external blockage or a dirty/wet external or internal filter. If the blockage is cleared the alarm will automatically cancel. Refer to instructions for changing the internal filters. If the problem does not resolve contact the service center for additional information. On rare occasions, this alarm can be triggered by a patient with a very high inspiratory demand. In this case increase the rise time or shorten the inspiratory time to increase the inspiratory flow rate.</p> <p><i>Mitigation/Info: Clear Fresh Gas Intake, Check Filter for Moisture or Dirt, OR, Manage Settings / Inspiratory Demand, **Manually Ventilate Patient**</i></p>
3032	<p>Self Check Fault</p> <p>Alarm triggers when communication between the Fresh Gas/Emergency Air Inlet pressure sensor is lost. Normal operation can continue but, if the condition is not cleared by powering off and restarting the device should be replaced when appropriate as. When used during this alarm condition the user should be sure to keep the Fresh Gas/Emergency Air Inlet clear and ensure that external filters are checked regularly.</p> <p><i>Mitigation/Info: Pneumatic Sensor, Ventilator Operating, Unable to Detect Inlet Obstruction, **Contact Ser-</i></p>
3041	<p>High O2 Supply Fault</p> <p>Alarm triggers when the high pressure O₂ supply is ≥ 80 psig (552 kPa) and < 87 psig (600 kPa). The alarm automatically cancels when the supply pressure is < 80 psig (552 kPa). Pressure above 87 psig (600kPa) could result in a catastrophic failure, harm to the patient and/or damage to the device. The user should reduce the O₂ supply pressure, sometimes this requires replacing the regulator that is not functioning correctly. If the pressure cannot be reduced and a low flow device like a flow meter is available the user can provide supplemental O₂ via the optional low flow O₂ reservoir. If not, the user should monitor the O₂ supply pressure and ensure that the pressure does not rise further.</p> <p><i>Mitigation/Info: Decrease O2 Supply Pressure, Replace Regulator, Connect Low Flow O2, Monitor SpO2</i></p>
3073	<p>Tubing Compliance Fault</p> <p>Alarm is triggered when the tubing compliance correction shows that it is $>$ the set tidal volume indicating that the patient may not be receiving the appropriate tidal volume. In this case the user should assess the patient and settings. Consult the attending physician if there are questions about how to configure the ventilator correctly to support the patient.</p> <p><i>Mitigation/Info: Calculated Compliance Volume Larger than Delivered Volume, Check Tubing Compliance vs. Circuit</i></p>
3091	<p>AutoPEEP</p> <p>Alarm triggers when the exhaled flow from the patient continues throughout the expiratory period causing the expiratory control valve to cycle throughout the period to maintain the baseline pressure. When this occurs the user should increase the expiratory period by decreasing the inspiratory time, decreasing the breathing rate or both. The physician should also be consulted as this alarm is an indication that Auto-PEEP is occurring. Note: at startup, this alarm is off. The user can choose to activate the alarm if they believe the patient is at risk of Auto-PEEP using the Alarm Configuration submenu that is access using the Main Menu.</p> <p><i>Mitigation/Info: Increase Expiratory Time, Decrease Inspiratory Time, Decrease Respiratory Rate, Disable</i></p>

3092	<p>Inspiratory Demand</p> <p>Alarm triggers when the end-inspiratory pressure is < -1.0 cm H₂O for 3 consecutive breaths. This can occur due to changes in the patient's status, where the patient attempts to inhale more gas than what is currently set. When this occurs, the user should note if the patient is breathing or fighting with the vent. The user should increase the flow rate (by decreasing the inspiratory time) and/or reduce the rise time. The physician should be consulted.</p> <p><i>Mitigation/Info: Patient May be Breathing with the Ventilator, Increase I Time and/or Decrease Rise Time, Check Patient and Circuit for Leaks, Disable Alarm, **Consult Physician**</i></p>
3110	<p>RTC Battery Low</p> <p>Alarm triggers when the real-time clock (RTC) battery is $< \sim 2.5$ volts. The alarm condition is checked at start up and if this alarm occurs the device is safe to operate but the user should replace the device when appropriate and consult the service center for additional information. The user cannot change the RTC battery. The RTC battery provides power for the clock that tracks the local time. It is replaced every 4 years during preventive maintenance.</p> <p><i>Mitigation/Info: Vent Fully Functional, **Contact Service Center**</i></p>
3120	<p>PM Due</p> <p>Alarm triggers at start up when the preselected number of days has elapsed since the last calibration. When appropriate the device should be replaced and sent for preventive maintenance. The low priority message serves as a reminder. Calibration is due every 365 days or 730 days for devices configured for stockpile use (check with your organization regarding the configuration of your device). Users should schedule the device for service as soon as possible. Users can suspend the yellow alarm notification for the current use by turning the alarm off using the Alarm Configuration submenu in the Main Menu.</p> <p><i>Mitigation/Info: Preventive Maintenance Due, Ventilator Functioning with No Faults, **When Appropriate, Con-</i></p>
3121	<p>Power Cycle Need</p> <p>This alarm occurs when the device has been running continuously for 30 days. In order to check the flow pneumotach, which is done a startup, the user should manually ventilate the patient and cycle the power. Once this is done the user can select the Last Settings options from the Start Menu and continue operation if not faults are detected during the self check. If nonoperating alarms occur, contact the service center for additional information.</p> <p><i>Mitigation/Info: Power-on Self Checks are Due, When Appropriate, Power Off Then On, Verify Proper Settings, **Review Manual For Additional Information**</i></p>
3130	<p>Self Check Fault</p> <p>Alarm triggers when the ambient pressure transducer fails. When this occurs, the device is no longer able to automatically compensate for changes in altitude especially in situations where the ambient pressure could change rapidly as during transport by air. When this alarm is active during aeromedical transport the user should ventilate using pressure targeting if the ventilator cannot be replaced. Users should also monitor chest rise and breath sounds to ensure adequate ventilation.</p> <p><i>Mitigation/Info: Sensor: Barometer, Altitude Compensation Disabled, Maintain Airway Pressure, Check Patient Chest Rise, Avoid Use At Varying Altitude, **Contact Service Center**</i></p>
3131	<p>Excessive Altitude</p> <p>Alarm triggers when the ambient pressure transducer detects an altitude $> 25,000$ feet (7620 meters). Beyond this altitude compensation remains fixed at the 25,000 ft compensation level. The user should monitor the airway pressure and reduce the tidal volume as altitude increases though, there is very little change in performance over this altitude. Where possible cabin pressure should be maintained in the compensated range.</p> <p><i>Mitigation/Info: Beyond Altitude Compensation Limit, Maintain Airway Pressure, Check Patient Chest Rise, Monitor Ventilator/Patient, **Reduce Altitude/ Pressurize Cabin if Possible**</i></p>

3132	<p>Low Altitude</p> <p>Alarm triggers when the ambient pressure transducer detects an altitude <-2,000 feet below sea level (610 meters, 15.8 psig or 103 kPa). This can be caused by use in subterranean rescue operation or mistaken use in a hyperbaric chamber. Beyond this pressure level compensation remains fixed at the -2,000 ft level. NOTE: the device is not intended for use in hyperbaric chambers or at hyperbaric pressures.</p> <p><i>Mitigation/Info: High Barometric Pressure Detected, Beyond Compensation Limit, Maintain Airway Pressure, Check Patient Chest Rise, Monitor Patient and Ventilator, **Reduce Ambient Pressure**</i></p>
3140	<p>Ambient Temperature Fault</p> <p>Alarm triggers when the ambient temperature exceeds the normal operating range, >131 °F (55 °C) for the ventilator. The device allows operation at these temperatures but alerts the user to the condition. Operating above the specified range can affect the longevity of the internal battery and the duration of operating time. When operating at high temperatures the user should remove the padded case which insulates and increases the ventilator's internal temperature.</p> <p><i>Mitigation/Info: High Temperature Detected, Remove Padded Case, **Monitor Patient and Ventilator**</i></p>
3141	<p>Ambient Temperature Fault</p> <p>Alarm triggers when the ambient temperature falls below the normal operating range <14 °F (-10 °C) for the ventilator. The device allows operation at these temperatures but alerts the user to the condition. Operating below the specified range can affect the longevity of the internal battery and the duration of operating time. At extreme cold temperatures operating time can be significantly reduced. When operating at low temperatures the user user use the padded case which insulates and increases the ventilator's internal temperature.</p> <p><i>Mitigation/Info: Low Temperature Detected, Use Padded Case, **Monitor Patient and Ventilator**</i></p>
3143	<p>Self Check Fault</p> <p>Alarm triggers when there is failure of the internal temperature sensors. When this occurs the device is no longer able to detect if it is operating outside of the allowable temperature range. If operating inside of the standard temperature range -25 °C to 49 °C (-13 °F to 120 °F) there is no effect on operation. If operating outside this range the user should monitor the device continuously. When appropriate the user should replace the ventilator and contact the service center for additional information.</p> <p><i>Mitigation/Info: Environmental Sensor: Temperature, Ventilator Operating, Service Required, **Contact Ser-</i></p>
3172	<p>Self Check Fault</p> <p>Alarm triggers when the device is not able to zero the airway pressure transducer during the autocal cycle. When this occurs the device is still able to monitor the airway pressure safely. Large changes in temperature should be avoided which can affect the calibration of the transducer. This alarm can also be triggered when the device is exposed to excessive vibration and/or is mounted in a vehicle in a manner that increases its exposure to vibration. If the alarm continues, replace the ventilator and contact the service center for additional information.</p> <p><i>Mitigation/Info: Pneumatic Sensor: Autocal, Reduce Vibration if Possible, Avoid Temperature Changes, Auto-</i></p>
3300	<p>Self Check Fault</p> <p>Alarm triggers when the pulse oximeter module fails and the user has turned off pulse oximeter monitoring acknowledging the condition. When this is done "stby" appears in the parameter windows for SpO₂ and HR as those parameters are no longer available. When appropriate the user should replace the ventilator and contact the service center for additional information.</p> <p><i>Mitigation/Info: Pulse Ox Module Not Available, SpO2/HR Not Available, **Contact Service Center**</i></p>
3301	<p>Self Check Fault</p> <p>Alarm triggers when the communication between the pulse oximeter module and device fails and the user has turned off pulse oximeter monitoring acknowledging the condition. When this is done "stby" appears in the parameter windows for SpO₂ and HR as those parameters are no longer available. When appropriate the user should replace the ventilator and contact the service center for additional information.</p> <p><i>Mitigation/Info: Internal COMM: Pulse Ox, SpO2/HR Not Available, **Contact Service Center**</i></p>

3310	<p>Pulse Ox Sensor Not Connected</p> <p>Alarm triggers when the pulse oximeter detects that no SpO₂ sensor is connected after a period of successful operation. NOTE: during start up the device automatically detects if a sensor is connected. If it is, the device begins operation with the pulse oximeter active. If no sensor is detected the device turns off this function. If the sensor is properly connected this failure can also be the result of a broken or defective sensor. If the alarm condition cannot be resolved the user should remove the sensor and turn off pulse oximetry monitoring using the SpO₂ Context menu to put the monitor in standby. Contact the service center for additional information.</p> <p><i>Mitigation/Info: Check Pulse Ox Sensor, Check Sensor/Ventilator Connection, Reinsert Sensor, Replace Cable/Sensor, Replace Sensor, **Contact Service Center**</i></p>
3311	<p>Defective Pulse Ox Sensor</p> <p>Alarm triggers when the pulse oximeter cannot identify the connected sensor or the sensor has failed. Causes for this alarm include: broken sensor cable, inoperative sensor LEDs and/or faulty detector. If the alarm condition cannot be resolved the user should suspend pulse oximetry monitoring by placing it in standby “stby” using the SpO₂ Context menu.</p> <p><i>Mitigation/Info: Check Pulse Ox Sensor, Check Sensor/ Ventilator Connection, Reinsert Sensor, Cable/Sensor Damaged?, Replace Sensor, **Turn Off Pulse Ox Monitoring**</i></p>
3312	<p>Pulse Search</p> <p>Alarm triggers when the pulse oximeter is searching for a pulse signal. If a value is not displayed within 30 seconds disconnect and reconnect sensor and reapply to the patient. If pulse search continues relocate it to a site that may have better perfusion. Replace the sensor if another sensor is available. If the alarm condition cannot be resolved the user should suspend pulse oximetry monitoring by placing it in standby “stby”.</p> <p><i>Mitigation/Info: Please Wait Acquiring Signal, Check Sensor Placement, Change Placement of Probe, Minimize Patient Movement, Check Sensor Operation/Replace, **Turn Off Pulse Ox Monitoring**</i></p>
3313	<p>Pulse Ox Signal Interference</p> <p>Alarm triggers when an outside signal or energy source prevents accurate reading by the device. When this occurs the patient should be moved from the location or pulse oximeter turned off.</p> <p><i>Mitigation/Info: External Signal Interfering With Measurement , Remove Patient From Location, **Turn Off Pulse Ox Monitoring**</i></p>
3315	<p>Ambient Light Fault</p> <p>Alarm triggers when there is too much ambient light on the SpO₂ sensor or there is inadequate tissue covering the sensor detector. Most often this alarm condition can be resolved by shielding the sensor from ambient light.</p> <p><i>Mitigation/Info: Too Much Ambient Light, Shield Sensor From Light, Change Sensor Placement, Check Sensor Operation, Replace Sensor, **Turn Off Pulse Ox Monitoring**</i></p>
3316	<p>Invalid Pulse Ox Sensor</p> <p>Alarm triggers when the pulse oximeter does not recognize the connected sensor, i.e. a non-Masimo sensor. The alarm can also occur when there is a broken sensor cable, inoperative LEDs, a fault is detected and/or the sensor has failed. To resolve the alarm condition the sensor should be replaced. If the alarm condition cannot be resolved the user should turn off pulse oximetry monitoring by placing it in standby “stby”.</p> <p><i>Mitigation/Info: Replace Sensor, **Turn Off Pulse Ox Monitoring**</i></p>
3317	<p>Low SpO₂ Perfusion</p> <p>Alarm triggers whenever the amplitude of the arterial pulsation is weak. Low perfusion typically occurs in patients with poor circulation or when the sensor is applied to the same limb as the noninvasive blood pressure (NIBP) cuff. To resolve the alarm condition, move the sensor to a better perfused site or to another limb if the interference is from the NIBP cuff.</p> <p><i>Mitigation/Info: Pulse Signal Weak, Check Sensor Placement, Change Sensor Placement, Check Sensor Operation, **Turn Off Pulse Ox Monitoring**</i></p>

3318	<p>Low SpO2 Perfusion</p> <p>Alarm triggers when the pulse oximeter determines the quality of the input signal is low due to excessive motion or artifact. To resolve the alarm minimize patient movement and make sure the sensor is properly applied.</p> <p><i>Mitigation/Info: Signal Artifact, Minimize Patient Movement, Check Sensor Placement, Check Sensor Operation, **Turn Off Pulse Ox Monitoring**</i></p>
3421	<p>External Power Low / Disconnect</p> <p>Alarm triggers when the external power (either AC or DC) drops below minimum level (~11 VDC as supplied by either the AC/DC Power Supply or a direct DC source) or power is intentionally disconnected. Since the device operates with either external power or using its internal battery this is a low priority alarm that clears when the user presses the Mute button. Pressing the Mute button is the user's acknowledgement that the device is operating on internal battery. If this alarm occurs and the user believes that the device is still connected to external power the user should investigate the external power source and contact the service center for additional information.</p> <p><i>Mitigation/Info: Internal Battery Operation, Check Power Connection/Supply, Monitor Battery Status</i></p>
3422	<p>Battery Fault</p> <p>Alarm triggers when the internal battery has been removed or communication between the battery and CPU has failed. When external power is applied the device is capable of operation however, loss of external power will result in loss of ventilation and a high priority alarm. Operating in this state should only be done when no other alternatives are available.</p> <p><i>Mitigation/Info: Battery Power Not Available, DO NOT Remove External Power!, Maintain External Power **Contact Service Center**</i></p>
3423	<p>Battery Charging Fault</p> <p>Alarm triggers when the battery charging circuit fails. When this alarm is active, the battery cannot be charged. The device can only run with external power. If power is lost, ventilator will stop and a high priority alarm will trigger. Operating in this state should only be done when no other alternatives are available. Contact the service center for additional information.</p> <p><i>Mitigation/Info: Ventilator Operating, Power System Needs Repair, Battery Cannot Charge, Maintain External Power, **Contact Service Center**</i></p>
3430	<p>Low Battery</p> <p>Alarm triggers when the device detects that there is <30 minutes of battery operation remaining and no external power is connected. The user should seek a source of external power and/or plan to provide manual ventilation. Attaching external power will immediately clear the alarm however, alarm #3431 will occur in its place, see below.</p> <p><i>Mitigation/Info: <30 Minutes Operation, Connect External Power, Ensure Ability to Manually Ventilate, **Contact Service Center**</i></p>
3431	<p>Low Battery</p> <p>This triggers when external power is connected to a device that has an internal battery that has drained to a low battery status. The device is warning the user that in the event of an external power failure the device has <30 minutes of backup. This alarm will resolve when the internal battery charge has >30 minutes of operation. The user must maintain constant monitoring of the device and the patient during this period.</p> <p><i>Mitigation/Info: <30 Minutes Operation, Operating With External Power, Continue Charging With External Power, Ensure Ability To Manually Ventilate, **Contact Service Center**</i></p>

3441	<p>External Power Fault</p> <p>Alarm triggers when the supplied DC power is >33 VDC. When this occurs the device automatically switches to operation using the internal battery. If the supplied voltage drops to <30 VDC the device automatically returns to operation using external power. If the external power source is known to be good then the AC/DC Power Supply may be faulty and need replacement. Contact the service center for additional information.</p> <p><i>Mitigation/Info: External Voltage Too High, Internal Battery Operation, Check/Replace Power Supply</i></p>
3442	<p>External Power Fault</p> <p>Alarm triggers when the external power supply has insufficient current. When this occurs the device automatically switches to operation using the internal battery. If the external power source is known to be good then the AC/DC Power Supply may be faulty and need replacement. Contact the service center for additional information.</p> <p><i>Mitigation/Info: External Power Insufficient Current, Internal Battery Operation, Check/Replace Power Supply, **Remove DC Connection**</i></p>
3442	<p>External Power Fault</p> <p>Alarm triggers when the voltage polarity is reversed when the device is attached to an external DC source. When this occurs the device automatically switches to operation using the internal battery. This condition is most likely caused by a faulty DC source. The user should seek an alternate power source.</p> <p><i>Mitigation/Info: DC Voltage Reversed, Internal Battery Operation, Disconnect Power Source</i></p> <p><i>**Replace Power Source**</i></p>
3450	<p>Battery Discharge Fault</p> <p>Alarm triggers when the battery temperature reaches 70 °C (158 °F) which is 5 °C from its maximum operating temperature and external power is connected. When the battery temperature reaches 75 °C (167 °F) the battery will shut down to prevent failure. When this occurs the device will continue operation using external power only. The device should be removed from the padded case which acts as insulation. Shading the patient and ventilator from direct sunlight may also help reduce the battery temperature.</p> <p><i>Mitigation/Info: Battery Within 5 °C of High Limit, Remove Padded Case, Continue External Power Operation, Shade Patient and Ventilator, **Move To Cooler Location**</i></p>
3451	<p>Battery Discharge Fault</p> <p>Alarm triggers when the battery temperature reaches ≥75 °C (167 °F) and external power is connected. Discharging the battery beyond this temperature could destroy the battery and damage the device. During the alarm condition the device will continue operation using external power. The device should be removed from the padded case which acts as insulation. Shading the patient and ventilator from direct sunlight may also help reduce the battery temperature.</p> <p><i>Mitigation/Info: Battery Too Hot to Discharge, Do NOT Remove External Power!, Remove Padded Case, Ensure Ability to Manually Ventilate Patient, **Move To Cooler Location**</i></p>
3452	<p>Battery Charging Fault</p> <p>Alarm triggers when the battery temperature is >45 °C (122 °F). Charging the battery above this temperature could destroy the battery and damage the device. During the alarm condition the device continues to operate using external power and if external power is lost the device will operate using internal battery power. The device should be removed from the padded case which acts as insulation. Shading the patient and ventilator from direct sunlight may also help reduce the battery temperature.</p> <p><i>Mitigation/Info: High Battery Temperature, Battery Does Not Charge When It is Too Hot, Ensure External Power Available, Remove Padded Case, Shade Patient and Ventilator, **Move To Cooler Location**</i></p>
3453	<p>Battery Charging Fault</p> <p>Alarm triggers when the battery temperature is ≤0 °C (32 °F). Charging the battery below this temperature could destroy the battery and damage the device. During the alarm condition the device continues to operate using external power and if external power is lost the device will operate using internal battery power. The padded case should be used because it provides insulation.</p> <p><i>Mitigation/Info: Battery Too Cold To Charge, Ensure External Power Available, Use Padded Case</i></p> <p><i>**Move to Warmer Location**</i></p>

3455	<p>Battery Fault</p> <p>Alarm triggers when the device is not able to communicate with the internal battery and external power is connected. To continue operation, the device must remain connected external power. Use in this state should only be done if there are no other alternatives. Contact the service center for additional information.</p> <p><i>Mitigation/Info: Battery Communication, Do Not Remove External Power, Ensure Ability to Manually Ventilate Patient, **Contact Service Center**</i></p>
3470	<p>Self Check Fault</p> <p>Alarm triggers when the device is no longer able to communicate with the Power Interface Module (PIM). When this occurs the user should monitor operation continuously, replace the ventilator when possible and ensure the ability to manually ventilate the patient. Contact the service center for additional information.</p> <p><i>Mitigation/Info: Power System, Power Management Fault, Ensure the Ability to Manually Ventilate the Patient, Monitor Power Source, **Replace/Service Ventilator**</i></p>
3480	<p>Self Check Fault</p> <p>Alarm triggers when the device software detects that it has not been calibrated with the SPM that is inside the device. This fault occurs when the biomedical technician fails to recalibrate the device following an SPM change or service. When this occurs the device should be replaced when appropriate and sent to the service center.</p> <p><i>Mitigation/Info: Serial Number Mismatch, Hardware Compatibility Failure, Update Calibration Records</i></p>

Pop Up Messages

Alarm Name/Information/Message
<p>Silent/Dark Mode Enabled</p> <p>Popup triggers when the user attempts to begin operation using Silent/Dark mode. In order to proceed the user must press the Accept button to begin operation. Note: not all devices are provided with the capability to operate with Silent/Dark mode, please check with your organization.</p> <p><i>Message: Press Accept Key to Enter Silent/Dark Mode Now</i></p>
<p>Requested Compressor Flow Too Low</p> <p>Popup triggers when the rate/tidal volume/FIO₂ combination requires a flow that is less than the flow capability of the compressor. Resolution involves changing a setting to increase the flow required from the compressor if possible. Note: this condition is only possible with infant setting and for FIO₂ <25%.</p> <p><i>Mitigation/Info: Reduce FIO₂, increase BPM, reduce I Time, or increase Vt</i></p>
<p>Requested Compressor Flow Too High</p> <p>Popup triggers when the user attempts to adjust the ventilator so that flow from the compressor is >100 l/min.</p> <p><i>Message: Cannot exceed 100 LPM total flow</i></p>
<p>Requested O₂ Flow Too Low</p> <p>Popup triggers when the rate/tidal volume/FIO₂ combination requires a flow that is less than the flow capability of the O₂ valve. Resolution involves changing a setting to increase the flow required from the O₂ valve if possible. Note: this condition is only possible with infant setting and for FIO₂ <25%. <i>Message: Increase FIO₂, increase BPM, reduce I Time, or increase Vt</i></p>
<p>Requested O₂ Flow Too High</p> <p>Popup triggers when the user attempts to adjust the ventilator so that flow from the O₂ valve is >100 l/min.</p> <p><i>Message: Cannot exceed 100 LPM total flow</i></p>
<p>Total Requested Flow Too High</p> <p>Popup triggers when the user attempts to adjust the ventilator so that the combined flow from the compressor and O₂ valve is >100 l/min.</p> <p><i>Message: Cannot exceed 100 LPM total flow</i></p>
<p>Requested Compressor Flow Too High</p> <p>Popup triggers when the user attempts to adjust the ventilator so that combined flow from the compressor and O₂ valve is <2 l/min.</p> <p><i>Message: Cannot flow less than 2 LPM total flow</i></p>
<p>Alarm Disable</p> <p>Popup triggers when the user attempts to adjust to disable an alarm by setting the value to 0 or the maximum value which would render the alarm essentially off.</p> <p><i>Message: Confirmation required -- press accept key to disable alarm</i></p>
<p>BPM Setting Conflict</p> <p>Popup triggers when the user attempts to set the BPM to a value that would result in an inspiratory time (I Time) >3 seconds.</p> <p><i>Message: I Time cannot exceed 3 seconds</i></p>

<p>BPM Setting Conflict</p> <p>Popup triggers when the user attempts to set the BPM to a value that would result in an inspiratory time (I Time) >5 seconds during inverse I:E ratio ventilation.</p> <p><i>Message: I Time cannot exceed 5 seconds with inverse I:E</i></p>
<p>E Time Range Exception</p> <p>Popup triggers when the user attempts to set the BPM to a value that would result in an expiratory time (E Time) <0.3 seconds.</p> <p><i>Message: E Time must be greater than 0.3 seconds</i></p>
<p>I:E Setting Conflict</p> <p>Popup triggers when the user attempts to transition from AC mode using an inverse I:E ratio to another mode where inverse I:E is not allowed.</p> <p><i>Message: Inverse I:E only allowed in AC - Mode change will reset I:E to 1:3</i></p>
<p>I:E Setting Conflict</p> <p>Popup triggers when the user attempts to set an inverse I:E ratio in a mode other than Assist/Control (AC).</p> <p><i>Message: Inverse I:E Not Allowed</i></p>
<p>BPM Setting Conflict</p> <p>Popup triggers when the user attempts to set a BPM rate that will result in an I:E ratio >1:99.</p> <p><i>Message: I:E > 1:99 not allowed</i></p>
<p>I Time Range Exception</p> <p>Popup triggers when the user attempts to adjust the ventilator so that flow from the compressor is >100 l/min.</p> <p><i>Message: Cannot exceed 100 LPM total flow</i></p>
<p>I Time Range Exception</p> <p>Popup triggers when the user attempts to SET inspiratory time (I Time) >5 seconds during inverse I:E ratio ventilation.</p> <p><i>Message: I Time cannot exceed 5 seconds with inverse I:E</i></p>
<p>I Time Range Exception</p> <p>Popup triggers when the user attempts to set an inspiratory time (I Time) <0.1 seconds.</p> <p><i>Message: I Time must be greater than 0.1 seconds</i></p>
<p>I:E Range Exception</p> <p>Popup triggers when the user attempts to set an inverse I:E ratio <4:1.</p> <p><i>Message: I:E < 4:1 not allowed</i></p>
<p>I:E Range Exception</p> <p>Popup triggers when the user attempts to set an I:E ratio >1:99.</p> <p><i>Message: I:E > 1:99 not allowed</i></p>
<p>Vt Limit Conflict</p> <p>Popup triggers when the user attempts to set the Vt lower than the Vt Low alarm limit.</p> <p><i>Message: Cannot adjust Vt Set below Vt Low Alarm</i></p>
<p>Vt Limit Conflict</p> <p>Popup triggers when the user attempts to set the Vt higher than the Vt High alarm limit.</p> <p><i>Message: Cannot adjust Vt Set above Vt High Limit</i></p>
<p>High Vt Setting</p> <p>Popup triggers when the user attempts to Vt >1000 ml. To do this, the user must press the Accept button and then continue to set a value >1000 ml followed by Accept again to confirm the setting change.</p> <p><i>Message: Confirmation required -- press accept key to allow Vt > 1000ml</i></p>

<p>PEEP Setting Conflict Popup triggers when the user attempts to set the PEEP setting ≤ 5 cm H₂O below the PIP High pressure limit. <i>Message: Cannot adjust PEEP target to within 5 of PIP High Limits</i></p>
<p>PEEP Setting Conflict Popup triggers when the user attempts to configure the ventilator so that the PEEP plus the pressure support (PS) are $>$ the PIP High pressure limit. <i>Message: PEEP + PS cannot be greater than PIP High Limit</i></p>
<p>PEEP Backup Setting Conflict Popup triggers when the user attempts to set the PEEP setting ≤ 5 cm H₂O below the Apnea Backup PIP pressure during CPAP or BL mode ventilation. <i>Message: Cannot adjust PEEP target to within 5 of backup PIP target</i></p>
<p>PEEP Setting Conflict Popup triggers when the user attempts to set the PEEP ≤ 5 cm H₂O below PIP pressure. <i>Message: Cannot adjust PEEP target to within 5 of PIP target</i></p>
<p>PEEP+PS Setting Conflict Popup triggers when the user attempts to set a combination of PEEP and PS that is < 3 cm H₂O. <i>Message: Cannot adjust PEEP+PS below 3</i></p>
<p>High Pressure Target Setting Popup triggers when the user attempts to set the PIP pressure > 60 cm H₂O. To do this, the user must press the Accept button and then continue to set a value > 60 cm H₂O followed by Accept again to confirm the setting change. <i>Message: Confirmation required -- press accept key to exceed 60 cmH2O</i></p>
<p>PIP Setting Conflict Popup triggers when the user attempts to set the PIP target ≤ 5 of PEEP pressure. <i>Message: Cannot adjust PIP target to less than 5 more than PEEP</i></p>
<p>PIP Setting Conflict Popup triggers when the user attempts to set the PIP $>$ the PIP High pressure limit. <i>Message: Cannot adjust PIP target higher than PIP High Limit</i></p>
<p>BPM Limit Conflict Popup triggers when the user attempts to set the PIP High pressure limit $<$ the PIP Low pressure limit. <i>Message: Cannot adjust high limit lower than low limit</i></p>
<p>Low Breath Rate Setting Popup triggers when the user attempts to set the BPM < 6 bpm. Doing this could, in effect, disable the alarm for some patients. To do this, the user must press the Accept button and then continue to set a value < 6 bpm followed by Accept again to confirm the setting change. <i>Message: Confirmation required -- press accept key for values below 6 BPM</i></p>
<p>BPM Limit Conflict Popup triggers when the user attempts to set the BPM Low limit $>$ the BPM High limit. <i>Message: Cannot adjust low limit higher than high limit</i></p>
<p>Vt Limit Conflict Popup triggers when the user attempts to set the Vt high limit $<$ the Vt low limit. <i>Message: Cannot adjust high limit lower than low limit</i></p>

<p>Vt Limit Backup Setting Conflict</p> <p>Popup triggers during CPAP or BL mode when the user attempts to set the Vt limit < the Vt low limit in the Apnea Backup settings.</p> <p><i>Message: Cannot adjust high limit lower than Backup Vt Setting</i></p>
<p>Vt Limit Conflict</p> <p>Popup triggers when the user attempts to set the Vt high limit < the Vt setting.</p> <p><i>Message: Cannot adjust high limit lower than Vt Setting</i></p>
<p>High Vt Limit Setting</p> <p>Popup triggers when the user attempts to set the Vt limit >1500 ml. Doing this could, in effect, disable the alarm for some patients. To do this, the user must press the Accept button and then continue to set a value >1500 ml followed by Accept again to confirm the setting change.</p> <p><i>Message: Confirmation required -- press accept key for values above 1500ml</i></p>
<p>Vt Limit Conflict</p> <p>Popup triggers when the user attempts to set the Vt low limit < Vt high limit.</p> <p><i>Message: Cannot adjust low limit higher than high limit</i></p>
<p>Vt Limit Conflict</p> <p>Popup triggers during SIMV (V) when the user attempts to set the Vt low limit > the current Vt.</p> <p><i>Message: Cannot adjust low limit higher than Vt Setting</i></p>
<p>High Pressure Limit Setting</p> <p>Popup triggers when the user attempts to set the PIP > 60 cm H₂O. To do this, the user must press the Accept button and then continue to set a PIP >60 cm H₂O followed by Accept again to confirm the setting change.</p> <p><i>Message: Confirmation required -- press accept key to exceed 60 cmH2O</i></p>
<p>PIP Limit Conflict</p> <p>Popup triggers when the user attempts to set the PIP High limit > the PIP Low limit.</p> <p><i>Message: Cannot adjust high limit lower than low limit</i></p>
<p>PIP Limit Backup Setting Conflict</p> <p>Popup triggers during CPAP or BL mode when the user attempts to set the PIP High limit < Apnea Backup PIP limit.</p> <p><i>Message: Cannot adjust high limit lower than backup PIP target</i></p>
<p>PIP Limit Conflict</p> <p>Popup triggers when the user attempts to set the PIP High limit < the PIP Low limit.</p> <p><i>Message: Cannot adjust high limit lower than PIP target</i></p>
<p>PIP Limit Conflict</p> <p>Popup triggers when the user attempts to set the PIP High limit < the combination of PS and PEEP pressures.</p> <p><i>Message: Cannot adjust high limit lower than PS + PEEP</i></p>
<p>PIP Limit Conflict</p> <p>Popup triggers when the user attempts to set the PIP Low limit > the PIP high limit.</p> <p><i>Message: Cannot adjust low limit higher than high limit</i></p>
<p>Heart Rate Limit Conflict</p> <p>Popup triggers when the user attempts to set the HR High limit < the HR Low limit.</p> <p><i>Message: Cannot adjust high limit lower than low limit</i></p>
<p>Heart Rate Limit Conflict</p> <p>Popup triggers when the user attempts to set the HR Low limit > the HR High limit.</p> <p><i>Message: Cannot adjust low limit higher than high limit</i></p>

<p>PS Conflict Popup triggers when the user attempts to set the PS > the PIP High limit - PEEP pressure. <i>Message: Cannot adjust PS higher than PIP High Limit - PEEP</i></p>
<p>Leak Comp. Popup triggers when the user attempts to initiate leak compensation (LC). To do this, the user must press the Accept button and then select LC followed by Accept again to confirm the setting change. <i>Message: Some Alarms Disabled! Configure Alarms for Patient!</i></p>
<p>Mode Conflict Popup triggers when the user attempts to initiate leak compensation (LC) during volume targeted ventilation. Note: LC is only available during pressure targeted ventilation. <i>Message: Cannot select Volume targeted control breaths with Leak Compensation on -- first turn Leak Compensation off</i></p>
<p>Inverse I:E Popup triggers when the user attempts to set an inverse I:E ratio. To do this, the user must press the Accept button and then adjust the I:E ratio to the desired inverse value and press Accept again to confirm the setting change. <i>Message: Confirmation required -- press accept key to allow inverse I:E</i></p>
<p>Excessive Volume for Infant Circuit Popup triggers when the user attempts to set a Vt >300 ml when the tubing compliance compensation is set to Pediatric. <i>Message: Press accept to confirm use of adult circuit</i></p>
<p>Insufficient Volume for Adult/Ped Circuit Popup triggers when the user attempts to set a Vt <200 ml when the tubing compliance compensation is set to Adult. <i>Message: Press accept to confirm use of infant circuit</i></p>
<p>High PEEP Setting Popup triggers during CPAP mode when the user attempts to set the PEEP >15 cm H₂O. To do this, the user must press the Accept button and then adjust PEEP to the desired value and press Accept again to confirm the setting change. <i>Message: Confirmation required -- press accept key to allow PEEP above 15</i></p>
<p>High EPAP Setting Popup triggers during BL mode when the user attempts to set the EPAP >15 cm H₂O. To do this, the user must press the Accept button and then adjust PEEP to the desired value and press Accept again to confirm the setting change. <i>Message: Confirmation required -- press accept key to allow EPAP above 15</i></p>
<p>EPAP Setting Conflict Popup triggers during BL mode when the user attempts to set the EPAP <3 cm H₂O below the IPAP target. <i>Message: Cannot adjust EPAP target to within 3 of IPAP target</i></p>
<p>EPAP Setting Conflict Popup triggers during BL mode when the user attempts to set the EPAP <5 cm H₂O below the Apnea Backup PIP target. <i>Message: Cannot adjust EPAP target to within 5 of backup PIP</i></p>
<p>PIP Limit Conflict Popup triggers during BL mode when the user attempts to set the peak inspiratory pressure (PIP) < the IPAP target. <i>Message: Cannot adjust high limit lower than IPAP target</i></p>

IPAP Setting Conflict

Popup triggers during BL mode when the user attempts to set the IPAP <3 cm H₂O above the EPAP setting.

Message: Cannot adjust IPAP target to less than 3 more than EPAP

IPAP Setting Conflict

Popup triggers during BL mode when the user attempts to set the IPAP < the PIP limit.

Message: Cannot adjust IPAP target higher than PIP High Limit

High IPAP Setting

Popup triggers during BL mode when the user attempts to set the IPAP >30 cm H₂O. To do this, the user must press the Accept button and then adjust IPAP to the desired value and press Accept again to confirm the setting change.

Message: Confirmation required -- press accept key to allow IPAP above 30 cmH₂O

High PEEP+PS Setting

Popup triggers CPAP mode when the user attempts to set the combination of PEEP + PS <30 cm H₂O. To do this, the user must press the Accept button and then adjust PEEP or PS to the desired value and press Accept again to confirm the setting change.

Message: Confirmation required -- press accept key to allow PEEP+PS above 30 cmH₂O

High Pressure Limit Setting

Popup triggers when the Start Menu is active and the user access either the Custom or Last Setting options and the PIP high limit is >35 cm H₂O. When the user selects one of the options where this is true, the Popup message is triggered require the user to provide additional conformation, pressing Accept, to initiate ventilation with the option.

Chapter 6

Operating Environments

This chapter describes how to operate the ZOLL Ventilator outside of a typical hospital environment. The types of environments that we describe are:

- Harsh environments -- prehospital and transport
- Hazardous environments -- in the presence of chemical and/or biological toxins
- MRI environments -- during MRI (magnetic resonance imaging) treatment

Using the ZOLL Ventilator in Harsh Environments

The ZOLL Ventilator operates in harsh prehospital environments and during air and ground transport. In order to safely manage the patient, you must understand the operating characteristics of the ventilator and diligently monitor the patient and device in these environments. The unit continuously monitors environmental conditions (temperature and ambient pressure) and when it detects extreme environments, the unit alerts you with a Low Priority alarm which defines the operating condition and prompts your actions. Low Priority alarms are advisory and you should remember that the device is operating as designed.

Airborne Particulates

Under normal operating conditions, the internal 2-stage filtration system protects the gas flow path from particulates entrained through the Fresh Gas/Emergency Air Intake. However, when operating in areas where fine dust or dirt is airborne due to wind or vehicle movement, you should use a disposable bacterial/viral filter to preserve the internal filter. Using disposable filters prevents you from having to change the ventilator's internal filters. Visually inspect the filter for dust/dirt build up for extended operation in harsh environments, you should change the filter as it becomes dirty.

The primary effect of entrained particles is on the operation of the flow pneumotach used to control the gas delivered to the patient. Dirt on the pneumotach screens affects the unit's calibration. Cleaning the screens requires a biomedical technician to disassemble the device and ultrasonically clean the screens. Using a filter in dusty environments prevents having to remove the unit from service for cleaning. In addition to using the filter, you can also keep the unit in the soft case, which will protect the unit case and the LCD from being scratched or damaged. It is also easier to clean the padded case following use in a dusty/dirty environment than the device.

Extreme Temperature Environments

Traditional transport ventilators typically operate from 0° to 40°C (32° to 104°F). The ZOLL Ventilator can operate over the range of -25° to 49°C (-13° to 120°F) during emergency situations.

Operating at High Temperatures

When operating the ventilator at high temperatures, you may observe alarm conditions associated with Li-ION battery performance:

Charging -- If operating using external power, the unit may issue an alarm when the battery reaches its high charge temperature limit of 45° C.

Discharging -- If operating using external power, the unit may issue an alarm when the battery reaches its high discharge temperature limit of 49° C.

Compliance is a physical characteristic of the ventilator that varies with temperature. The circuit becomes more compliant as the temperature rises. The ZOLL ventilator allows you to increase the compliance value when operating in hot environments.

When operating at high temperatures, you should remove the unit from its padded case, which allows the unit to pass heat into the surrounding environment.

Operating at Low Temperatures

When operating the ventilator at low temperatures, you may observe alarm conditions associated with Li-ION battery performance:

Charging -- If operating using external power, the unit may issue an alarm when the battery reaches its low charge temperature limit of 0° C.

Discharging -- If operating using external power, the unit may issue an alarm when the battery reaches its low discharge temperature limit of -25° C.

Compliance is a physical characteristic of the ventilator that varies with temperature. The circuit becomes less compliant as the temperature drops. The ZOLL ventilator allows you to decrease the compliance value when operating in cold environments.

Valve operating performance can be affected by extremely low temperatures. Consequently, at low temperatures, you should monitor the patient to ensure that the patient is receiving adequate tidal volume and monitor the patient's SpO₂ readings.

When operating at low temperatures, you can improve performance by operating the unit in the padded case, which insulates the unit and allows it to retain heat generated by the compressor, circuit boards, and AC/DC Power Supply.

Altitude

The ZOLL 731 Series Ventilator is designed to operate from -610 to 7620 meters (-2,000 to 25,000 feet). An absolute barometric pressure sensor monitors ambient pressure and the unit uses this information to continuously correct the output of the device to maintain the ventilation parameters. When the altitude is > 25,000 feet, the unit activates a Low Priority alarm. When this occurs, you should monitor the peak inspiratory pressure (PIP) and adjust the tidal volume to maintain the PIP and monitor breath sounds and chest excursion to assure the unit maintains adequate ventilation. The tidal volume increases as altitude increases, so you should look to prevent over-pressurization of the lung when the altitude increases beyond 25,000 feet. If changes are made above 25,000 feet, you should revert to the initial settings once operation resumes in the compensated range (the LED will turn from yellow to green).

Warning! **The unit is not intended for hyperbaric operation. Use in a hyperbaric chamber can result in harm to the patient and/or damage to the device.**

Rain and Snow

You should prevent exposing the unit to rain or snow. Use the optional padded case that can be purchased with the ZOLL Ventilator to protect the 731 Series Ventilator from rain and snow. The unit is capable of operating in these conditions if you keep the device in the padded case and use the rain flap that is provided with the padded case. The padded case and rain flap prevent rain and snow from puddling on any of the device's surfaces. In cases of driving rain, where water could possibly enter the unit's compressor, you can use a bacterial/viral filter to protect the compressor inlet.

Using the ZOLL Ventilator in Hazardous Environments

You can use the ZOLL Ventilator in environments where chemical and/or biological toxins are present. To do this safely, all gas delivered to the patient comes from either a pressurized medical-grade oxygen source and/or filtered ambient air entrained through the Fresh Gas/Emergency Air Intake. You can choose between a bacterial/viral filter and a chemical/biological filter based on the direction of the Medical Control Officer.

To prevent the patient from breathing contaminated ambient air in the event of a ventilator failure, the unit contains an internal anti-asphyxia valve that allows the patient to inspire gas through the external filter. While this design assures that no contaminated gas reaches the patient, you are required to ensure that nothing blocks the input of the external filter.

Warning! The Medical Control Officer and/or Incident Commander should determine which, if any, external filter is used based on the potential hazard.

Warning! You must ensure that nothing blocks the inlet of the external filter; failure to do so could prevent the patient from breathing and cause an ventilator failure.

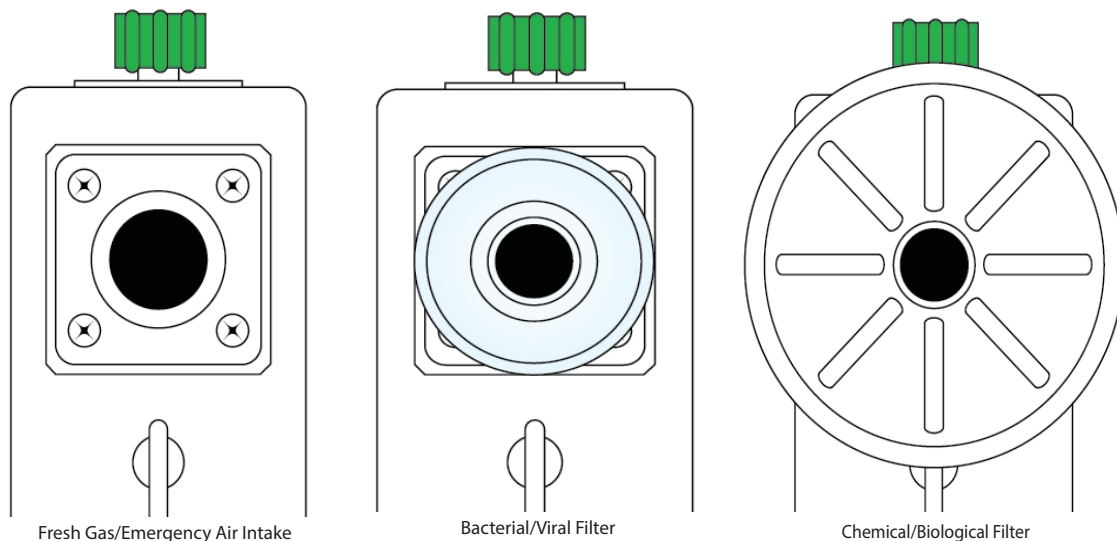

Hazardous Environment Filters

Bacterial/Viral Filter Use

You can use Bacterial/Viral (B/V) filters in environments where the patient is at risk from cross contamination or airborne pathogens. When used in accordance with the manufacturer's instructions, these filters can help prevent inhalation of infectious matter. In dusty environments, you can also use the B/V filters to prevent entrainment of particulate matter that could affect the ventilator's pneumatic components. To use a bacterial/viral filter, insert the filter's male 22 mm conical fitting into the Fresh Gas/Emergency Air Intake.

Caution If filters have been exposed to biological matter, dispose of them following the Universal Precaution procedures for your facility.

Chemical/Biological Filter Use

The ZOLL 731 Series Ventilator is designed to allow attachment of chemical/biological filter/canister (type C2A1¹) for use in contaminated environments. The Fresh Gas/Emergency Air Intake fitting allows for attachment of standard Rd 40 x 1/7 threads. A complete description of this standard can be found in BS EN 148-1:1999 Respiratory protective devices - Threads for face pieces.

Check Valve on Breathing Circuit when in Hazardous Environments

When operating in a Hazardous Situation where a chemical/biological filter is in use, you should use a Check Valve (**REF** 704-0700-01) to prevent hazardous gas from entering the patient's breathing circuit. The exhalation valve on the breathing circuit is not adequate to protect patients if they rapidly inhale/exhale as the valve may not fully close in time to prevent hazardous gas entrainment. Also, if the PEEP is set low, patients may inhale faster than the flow is delivered which could cause hazardous gas entrainment. Consequently, a Check Valve is required to protect patients.

1. A 3M C2A1 canister (3M St. Paul, MN) was used in our validation testing to represent the class of filters generically known as C2A1 under the NSN number 4240-01-361-1319. These tests confirmed the performance of the ventilator when operating with these devices as a class. Use of the 3M canister does not constitute endorsement or recommendation of the 3M device. Use and selection of the appropriate filter should always be under the direction of the Incident Commander.

Warning! The unit is shipped with both the pediatric/adult and infant/pediatric single limb circuits. A Check Valve (704-0700-01) is required with these breathing circuits when operating in a hazardous environment. The correct mating of the Check Valve with the breathing circuit is shown below. Operators who anticipate use in these environments should also stock the Check Valve.

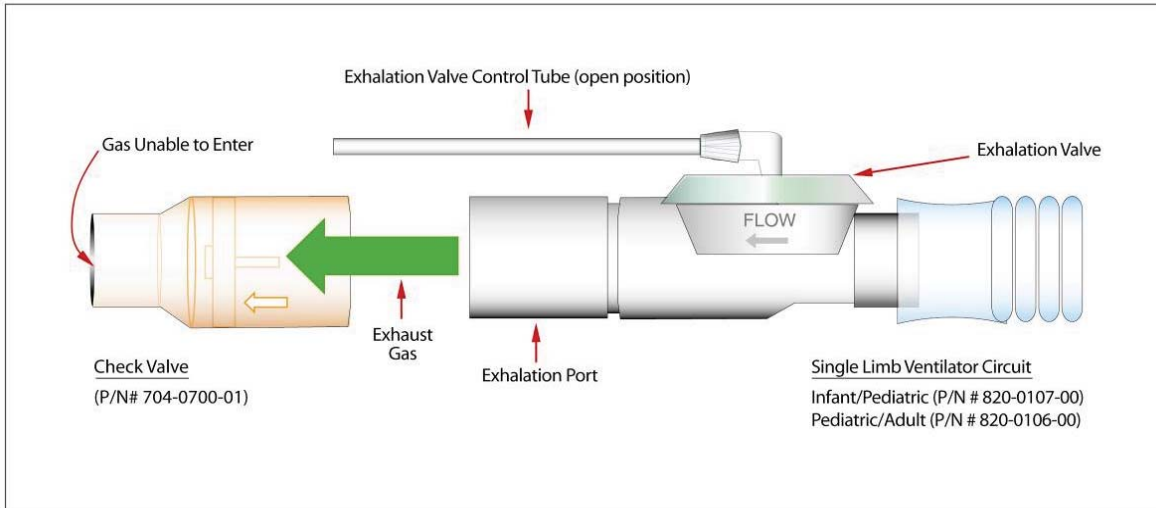

Check Valve Connection To Breathing Circuit

Using the ZOLL Ventilator in an MRI Environment

You can use ZOLL's MRI-compliant EMV+[®] and Eagle II[™] ventilators in an MRI environment while securely mounted to the ZOLL MRI Roll Stand (REF 816-0731-01) with the Aluminum IV Support Arm (REF 820-0124-00).

To securely mount the ventilator, tighten the knob on the back plate of the roll stand to hold the ventilator in position, then lock the roll stand wheels (we also recommend that you tether the rolling stand in place):

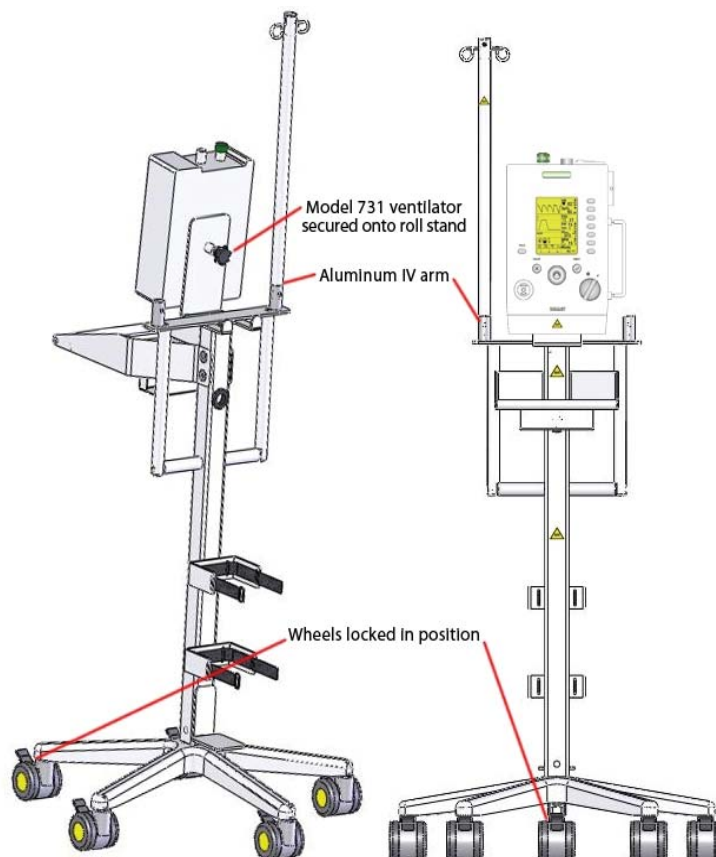

731 Series Ventilator Mounted On MRI Rolling Stand With IV Support Arm



Before using the ventilator in an MRI environment, it is important that you read and understand all warnings in the “Ferromagnetic Equipment” Section of Chapter 1.

Warning! Use only ZOLL's EMV+ and Eagle II Ventilators marked with the MR symbol in the MRI environment.



Caution The use of longer breathing circuits may increase the risk of self-triggering ventilator breaths. Reducing the pressure trigger sensitivity may solve this problem.

Chapter 7

Maintenance

This chapter describes how to maintain the ZOLL Ventilator to ensure its optimum working condition and readiness for immediate use. Specifically, this chapter describes how to

- Inspect the device
- Clean the device
- Replace intake filters, as necessary
- Store the device
- Troubleshoot operational problems

In addition to the activities that we describe in this chapter, it is also important to perform preventative maintenance, replacing worn or defective components, as necessary. Only ZOLL-trained and certified personnel should perform preventative maintenance using ZOLL's RCS system.

Inspecting the ZOLL Ventilator

You should perform the following physical inspections of the ZOLL Ventilator on a regular basis:

- Ensure that the ventilator is clean and free of visible damage.
- Inspect all accessories and connectors for signs of damage or excessive wear. Replace worn or defective items.
- Examine high pressure hoses for cracking, discoloration, or disfigurement. Examine end connection fittings for damaged threads and sharp edges. Replace worn or defective hoses -- DO NOT attempt to repair hoses.
- Examine the ventilator circuits for damage or wear including cracking or discoloration. If there are signs of physical degradation or the unit is indicating ventilator circuit problems, replace the circuit.
- Examine the filters and replace them if dirty or clogged.
- Inspect the external AC /DC adapter, line cords, and DC power cables for wear or damage. Replace if worn or damaged.

Configuration and firmware information appears on the display screen after powering on the device. Additional device information is available through the Main Menu (select **Unit Info**), including the unit's calibration date. The ZOLL Ventilator operates on an annual preventative maintenance cycle, and the device issues a low priority alarm to remind you when calibration is due.

Cleaning

Keep the ventilator and its accessories clean at all times. Never allow grease or oil to enter the system or coat its components.

Clean the unit at regular intervals and maintain up-to-date records of inspections, cleaning, and maintenance.

Take care to prevent liquids from entering the ventilator. *Never* submerge the ventilator and avoid using excessive amounts of water that might enter the unit. Dry all exposed parts following usage in wet environments.

Clean the unit's housing and hose connections with a damp, soapy cloth.

For general decontamination and cleaning, apply a 10% bleach solution with a damp cloth.

Do not clean the unit with abrasives or chlorinated hydrocarbon cleansers, which damage the housing and interface lens.

After cleaning, thoroughly dry the unit with a lint-free cloth. Make sure that all exposed surfaces are cleaned and dried.

Warning! **Never use oil or grease of any kind with oxygen or compressed gas equipment.**

Post-Contaminated Environment Cleaning

If you have used the ZOLL Ventilator in an environment where it may have been exposed to contamination from a hazardous materials accident, mass epidemic, or weapon of mass destruction, we recommend that you follow these guidelines:

1. Always follow the decontamination procedures specified by the local Incident Command Safety Officer.
2. You should clean and decontaminate the equipment as soon as possible after use. Personnel should always wear the appropriate Personal Protective Equipment while decontaminating equipment.
3. *Review the cleaning instructions that we provide in the previous section.*
4. Since the potential amount of contaminants that the ventilator might be exposed to is so large, it is difficult to provide an appropriate cleaning method for each type of exposure. An effective cleaning agent for one type of exposure may not be effective with another. Cleaning and sterilizing practices may vary between institutions. We suggest that each facility have in place a procedure for the cleaning and disinfection of its medical equipment and that these procedures be consulted for further guidance.

Gas Intake Filters

The fresh gas intake (located on the right side of the ventilator) has a two stage filtering system: an easily accessible foam filter protects a second disk filter. As we describe in Chapter 6, “Operating Environments,” additional filter protection may be necessary when operating the unit in extreme environments.

Inspecting and Replacing the Foam Filter

When used in dusty environments, you should inspect and replace, if necessary, the unit’s foam filter (**REF** 465-0028-00).

Remove the filter using a pair of tweezers or similar tool. Examine the filter for dirt, lint, or general wear. Replace the foam filter, if necessary. **DO NOT** attempt to clean the filter.

Caution Do not operate the compressor without a filter in place.

Inspecting and Replacing the Disk Filter

The Fresh Gas/Emergency Air Intake Disk Filter (**REF** 465-0027-00) is located behind the Foam Filter. This filter provides a second level of filtration to the ambient air that is delivered to the patient. You must check this filter periodically and replace it if necessary. The ZOLL Ventilator triggers an alarm when the combination of Foam Filter and Fresh Gas/Emergency Air Intake Disk Filter become dirty. This alarm indicates that the unit is still able to deliver the correct tidal volume but one or more of its filters needs replacement. You can visually inspect the Fresh Gas/Emergency Air Intake Disk Filter after the Foam Filter is removed. If the filter appears discolored, replace it.

Caution There are no user serviceable parts except the filter components above.

Caution When used in dusty/dirty environments, you should check the foam and disk filters, and replace them as needed. This prevents particle build up on the transducer screen and the need to take the unit out of service for maintenance by a biomedical technician.

Caution If filters are exposed to biological matter, dispose of them following Universal Precaution procedures for your facility.

Note: Do not attempt to clean this filter and do not operate the internal compressor without a filter in place.

Replacing the ZOLL Ventilator's Filters

Tools needed:

- Hemostat or tweezers
- Phillips Head screwdriver



Warning! Before attempting to replace filters, make sure that external power is disconnected and that the ventilator's power switch is set to "OFF".

Replacing the Foam Filter

The Foam Filter is located inside the Compressor Inlet Fitting.

1. Carefully remove the Foam Filter using a hemostat or tweezers.



DO NOT reuse or attempt to clean the old filter.

2. **Replace the Foam Filter with a new filter.** Lightly tap the new filter into place. The top of the filter should reside approximately 3/4 to 7/8" below the height of the 22 mm female connector that is part of the Compressor Inlet Fitting.



Replacing the Disk Filter



1. Remove the four (4) 8-32 x 3 Phillips Flat Head screws that secure the Compressor Inlet Fitting Assembly to the cover.

2. **Lift the two (2) segments of the Compressor Inlet Fitting Assembly away from the unit.** If the two segments come apart, **do not** lose the gasket that seats between the parts.



Alignment Pins

The Disk Filter is now exposed. **Do not** remove the filter at this time.

3. **Examine the surface of the Disk Filter.** **Do not** replace the Disk Filter if it isn't discolored. If the Disk Filter is discolored, replace the filter.



Remove the Disk Filter using the hemostat or tweezers and replace it with a new, clean filter. Make sure that the filter sits flat on the shoulder in its recessed area.



4. **Set the lower segment of the Compressor Inlet Fitting Assembly into the unit, making sure that its alignment pin mates.**

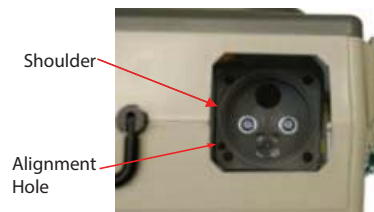

5. **Set the upper segment of the Compressor Inlet Fitting Assembly into the lower segment, making sure that its alignment pin mates.**
6. **Secure the Compressor Inlet Fitting Assembly to the device by equally tightening each of the four (4) 8-32 x 3 Phillips Flat Head screws.**

Momentarily turn the unit's **POWER** switch to its "ON" position to confirm operating power.

A **DISCONNECT** alarm sounds.

Turn the unit's **POWER** switch to its "OFF" position.

Battery Maintenance

The ZOLL Ventilator uses a rechargeable lithium-ion battery, which offers a wide temperature operating range, does not exhibit "memory" characteristics (reduced capacity), or vent hydrogen gas. Avoid exposing the battery to direct sunlight or heat sources. Never store the

battery at temperatures above 76°C (170°F) for more than 2 hours to prevent premature charge depletion and the reduction of battery life.

Following the guidelines that we describe in this chapter prevents premature charge depletion of the battery's charge and reduction of battery's life.

Observe the warnings and cautions and that follow for safe use of the battery:

Warning! **If you witness a battery or the battery compartment starting to balloon, swell up, smoke, or feel excessively hot, turn off the unit, disconnect external power, and observe it in a safe place for approximately 15 minutes and send the unit for service. Never puncture or disassemble the battery packs or cells.**

Caution Only use the Power Supply provided with the device (**REF** 703-0731-01). Use of any other power supply could cause damage or create a fire and/or destroy the battery and ventilator.

Caution Never attempt to completely discharge the battery by shorting it or some other method and never ship the battery in a completely discharged state.

Caution During continuous, uninterrupted use (>100 hours), you should disconnect the ventilator from AC power for 30 seconds to allow the battery to run diagnostics while the battery is discharging.

Note: The ZOLL Ventilator continuously monitors the available power sources; occasionally a false Low Priority power alarm can be triggered for approximately 1 second. These false alarms immediately clear themselves.

While the unit is operating on battery power, you can best determine the relative amount of charge in the internal battery by looking at the BATTERY Icon. The BATTERY icon appears in outline form and is filled with horizontal rows of lines indicating its current capacity. Each line represents approximately 5% of battery capacity.

The ventilator monitors temperature and controls the charging and discharging of the battery under the following conditions:

- -20°C to 75°C (-4°F to 167°F) for discharging.
- 0°C to 45°C (32°F to 113°F) for charging.

Best operating conditions are 15°C to 40°C (59°F to 104°F).

The battery rapidly recharges to 90% of its capacity in approximately 2 hours. It takes approximately another 2 hours of trickle-charging to top off the battery to 100% of its capacity.

Continuous charging is permissible with the AC/DC power Supply and 12 VDC Power Cable that ZOLL provides.

Battery Storage

Lithium Ion batteries discharge during storage. Higher temperatures (above 20C or 68F) reduce the battery storage life.

Follow these rules to ensure the best storage life of the ZOLL Ventilator's batteries:

1. Always store the ventilator with the battery fully charged. DO NOT store the ventilator with the batteries discharged.
2. For long-term storage, the optimum storage temperature range is -15 C to 21 C (5 F to 71 F). Avoid exposing the battery to direct sunlight or heat sources. Never store the battery at temperatures above 76°C (170°F) for more than 2 hours to prevent premature charge depletion and the reduction of battery life.
3. If long-term storage/non-use is common, recharge the unit every six months; this ensures that the battery charge is maintained at 80% capacity or better.
4. When batteries are in extended storage, you should charge them at recommended intervals when *not* continuously connected to an external power source:

STORAGE AMBIENT	RECHARGE INTERVAL
Below 68°F (20°C)	12 months
68°F to 86°F (20°C to 30°C)	6 months
86°F to 104°F (30°C to 40°C)	3 months

Note: When charging in the storage case, be advised that the battery may stop charging if ambient temperature is above 40°C/104°F, even though the unit is still connected to external power. Under these conditions, battery temperature can get as high as 10°C/50°F above the ambient temperature. Charging automatically starts when the ambient temperature drops.



ZOLL Ventilator Storage Case

Caution DO NOT store the ventilator with batteries in a discharged condition.

Ventilator Storage

Follow the battery storage recommendations that we describe in this chapter.

Following 6 months (or longer) of continuous storage or non-use, inspect the device, perform an Operational Test, and recharge the unit's batteries before attempting to use it with a patient.

If the device has been stored in non-controlled environments (such as a vehicle), allow the unit sufficient time to stabilize to a temperature within its specified operating range.

The ZOLL Ventilator is available with transit and carry case options. Follow the instructions that we provide with the transit or carry case.

Battery Replacement and Shipping Regulations

Only trained technicians at a authorized ZOLL Service Center can replace the ventilator's battery. Contact your local service center for return instructions and please note the following:

- Shipping of the ZOLL Ventilator's battery should always use proper State of Charge (SOC), which must never exceed 30%. The ventilator's Rechargeable Lithium Ion battery follows these and other important regulations, which IATA/DOT UN 38.3 mandates.
- The ventilator's battery is less than 100Wh, and thus is Classified as Class 9 Exempt and does not require Class 9 labeling or marking.
- Always check all applicable local, national, and international regulations before transporting a Lithium-Ion battery.
- Transporting an end-of-life, damaged, or recalled battery may, in certain cases, be specifically limited or prohibited.

Calibration Checks

The ZOLL Ventilator continuously performs a self check to monitor the pneumatic system.

You should always check the ventilator's calibration as part of the annual service procedure. You should check the ventilator's calibration:

- Every 12 months.
- Whenever significant usage warrants a shorter period between preventative maintenance inspections.
- Whenever you suspect the unit is not functioning properly.
- Following mass deployment before the device is returned to storage.

You should perform maintain a secure record of calibration checks for devices not returned to ZOLL for calibration/maintenance. If the unit fails the calibration check, it should be returned to ZOLL or an authorized Service Center for calibration.

To perform a calibration check, you must use ZOLL's RCS system; only ZOLL-trained and certified personnel can use the ZOLL RCS system.

Electrical Safety Check

The ventilator's power system has an internal protection system that the device continuously monitors. In event of a fault or failure condition. the device indicates a self-check alarm.

The ZOLL Ventilator is double insulated, and is categorized as both Class I or Class II meeting all regulatory codes. When attached to the an AC power supply the ventilator's external AC/DC converter protects the device in two steps:

-
1. Class I: Basic Insulation: the earth grounding provides a dissipation route under this fault condition. Under fault conditions with resistances of 100 mΩ or less, the AC/DC converter shunts the current away and opens the safety fuse or breaker.
 2. Class II - Supplementary Insulation: the impedance of the isolation barrier integral to the AC power supply provides the protection to the user and patient. Under high voltage fault conditions, the device relies on isolation of the high voltage internal circuitry from the equipment's enclosure as the safety countermeasure.

Protection against electric shock does not rely on Basic Insulation only, but includes an additional safety precaution that prevents accessible metal parts from becoming live should the basic insulation fail.

Protective grounding testing, typical for many medical devices, is applicable only to Class I equipment. The ventilator's electrical safety design is not dependent on earth grounding as the means of protection.

Troubleshooting

You can quickly address common problems by following the alarm mitigation instructions. Should this device fail to operate properly, verify the integrity of all accessories, ventilator circuits, and fitting connections. Check all control panel settings and follow the alarm mitigation instructions provided by the ventilator's Smart Help messages.

Verify that the Fresh Gas/Emergency Air Intake Disk Filter and Foam Filter are not clogged or dirty. Check for operating power with internal batteries and external power sources.

If the tests above do not resolve an operating problem, service is required. Contact the closest authorized ZOLL Service Center or the ZOLL Customer Service Department.

Appendix A

Specifications

General

Parameter	Operating Range
Operating Modes	EMV+ [®] and Eagle II [™] : AC, SIMV, CPAP with and without Pressure Support, BL Modes, and Leak Compensation for Active and Noninvasive ventilation. AEV [®] : AC, CPAP (with and without Pressure Support), BL Modes, and Leak Compensation for Noninvasive ventilation.)
Breath Target	Volume or Pressure
Flow Rate	0 to 100 LPM at 40 cm H ₂ O
Breath Rate	1 to 80 BPM ± 1 BPM over the interval Setting Resolution: 1 BPM Measurement: 1 to 90 BPM ± 1 BPM over the interval
Inspiratory Time (Ti)	Setting: 0 to 3 ± s for I:E ratio > 1:1.0, 0 to 5 ± s for E:I ratio ≤ 1.0:1 Setting Resolution: 0.05 s
Tidal Volume	Setting: 50 to 2000 ml ATPD ± (5 ml +10% setting) Setting Resolution: 10 ml Measurement: 0 to 9999 ml ATPD ± (5 ml +10% setting)
FIO ₂	21 to 100% (± 3% of full scale ± 10% of setting)
PEEP/EPAP	Setting: 0 to 30 cm H ₂ O ± (2 cm H ₂ O + 8% of reading) Setting Resolution: 10 ml Measurement: 0 to 30 cm H ₂ O ± (2 cm H ₂ O + 8% of reading)
Peak Inspiratory Pressure (PIP)	Setting: 10 to 80 cm H ₂ O (± 2 cm H ₂ O ± 8% of setting) Setting Resolution: 1 cm H ₂ O Measurement: 0 to 99 cm H ₂ O ± (2 cm H ₂ O + 8% of reading)

SPECIFICATIONS

Parameter	Operating Range
Pressure Support (PS)/ IPAP	0 to 60 cm H ₂ O ± (2 cm H ₂ O + 8% of setting) NOTE: IPAP must always be greater than or equal to 3 cm H ₂ O.
Oxygen Input Pressure	55 psig
Mean Airway Pressure (MAP)	Reading: 0 to 99.9 cm H ₂ O ± (2 cm H ₂ O +8% of reading) Resolution: 1 cm H ₂ O
Airway Pressure High Limit	Setting: 20 to 100 cm H ₂ O Setting Resolution: 1 cm H ₂ O
Airway Pressure Low Limit	Setting: Off, 3 to 35 cm H ₂ O Setting Resolution: 1 cm H ₂ O
Breath Trigger	-6.0 to -0.5 cm H ₂ O (± 0.25 cm H ₂ O + 5% of setting) below
Airway Pressure Waveform	0 to 99 cm H ₂ O ± (2 cm H ₂ O + 8% of reading)
Minute Volume	0 to 99.9 lpm ± 0.1 lpm + 8% of reading
LED Status/Alarm Indicator	Red, Yellow, and Green
Alarm Volume	82 dBA @ 1 meter
Noise Level	~60 dBA when measured at 1 meter (operating at default settings using the compressor only)
Operating Voltages	AC Supply: 100 to 240 VAC (50/60 and 400 Hz) -- use only the AC/DC power supply that ZOLL provides with the device. DC Supply: Nominal 12.5 to 28.0 VDC (accepts DC voltages between 11.8 to 30 VDC).
Operating Time Internal Battery	10 hours at default settings
Ventilator Temperature Ranges	Operating Extreme: -25°C to 49°C (-18°F to 120°F)
Battery Temperature Ranges	Battery Charge: 0°C to 45°C (32°F to 113°F)
Size	8.0" Wide X 12.5" High X 4.5" Deep (20.3 cm Wide X 31.8 cm High X 11.4 cm Deep)
Weight	~9.7 lbs (4.4 kg)
Warranty	Limited, 1 year

Pulse Oximeter

Range

Saturation (% SpO ₂)	1%-100%
Pulse Rate (bpm)	25-240
Perfusion	0.02%-20%

Accuracy

Saturation (% SpO₂)-During No Motion Conditions

Adults, Pediatrics	70%-100% ± 2 digits 0%-69% unspecified
Neonates	70%-100% ± 3 digits 0%-69% unspecified

Saturation (% SpO₂)-During Motion Conditions

Adults, Pediatrics	70%-100% ± 3 digits 0%-69% unspecified
Neonates	70%-100% ± 3 digits 0%-69% unspecified

Pulse Rate (bpm)-During No Motion Conditions

Adults, Pediatric, Neonates 25 to 240 ± 3 digits

Pulse Rate (bpm)-During Motion Conditions

Adults, Pediatric, Neonates 25 to 240 ± 5 digits

Resolution

Saturation (% SpO₂) 1%
Pulse Rate (bpm) 1

Low Perfusion Performance

>0.02% Pulse Amplitude Saturation (% SpO₂) ± 2 digits
and % Transmission >5% Pulse Rate ± 3 digits

Interfering Substances

Carboxyhemoglobin may erroneously increase readings. The level of increase is approximately equal to the amount of carboxyhemoglobin present. Dyes, or any substance containing dyes, that change usual arterial pigmentation may cause erroneous readings.

Device Classification

The following table describes the ZOLL Ventilator’s device classification:

Category	Classification
Type of Protection against Electric Shock	The medical power supply (which contains the system’s safety barrier) is labeled as Class I or Class II. Electrical shock protection is not dependent upon earthing since this power supply design includes double insulation.
Degree of Protection against Electric Shock Applied Parts	The ventilator circuit is Type BF applied part. The pulse oximeter is Type BF Defibrillation Proof Applied Part.
Degree of Protection against Harmful Ingress of Water	IPX4: Splash-proof equipment rating, include: <ul style="list-style-type: none"> • Padded case with rain flap • Bacterial/viral filter to protect the compressor
Method of Sterilization or Disinfection	O2 Supply hoses and connections should be wiped with a damp, soapy cloth and thoroughly dried with a lint-free cloth. The unit’s housing should also be cleaned as necessary with a damp, soapy cloth and thoroughly dried with a lint-free cloth. Do not clean with abrasives or chlorinated hydrocarbon cleansers. Ventilator circuits are only for single use. Follow all IFU instructions.
Degree of Safety of Application in the presence of a Flammable Anesthetic Mixture with Air or with Oxygen or Nitrous Oxide	Equipment <i>not</i> suitable for use in presence of Flammable Anesthetic Mixture of Air or with Oxygen or Nitrous Oxide
Mode of Operation	Continuous Operation

The device meets the electromagnetic tests as specified by regulations. The following tables provide guidance as to the environments in which you can operate the device.

Emissions test	Compliance	Electromagnetic environment-guidance
RF emissions CISPR 11	Group 1	The ZOLL ventilators use RF energy only for their internal function. Therefore, their RF emissions are very low and are not likely to cause any interference in nearby electronic equipment.
RF emissions CISPR 11	Class A	The ZOLL ventilators are suitable for use in all establishments other than domestic and those directly connected to the public low-voltage power supply network that supplies buildings used for domestic purposes.
Harmonic emissions IEF 61000-3-2	Class A	
Voltage fluctuations/flicker emissions IEC 61000-3-3	Complies	

The ZOLL ventilators are intended for use in the electromagnetic environment specified below. The customer or user of the ventilator should ensure that they are used in such an environment

f

Immunity Test	Test level	Compliance level	Electromagnetic environment-guidance
Electrostatic discharge (ESD) IEC 61000-4-2	+/- 6 kV contact +/- 8 kV air	+/- 6 kV contact +/- 8 kV air	Floors should be wood, concrete, or ceramic tile. If floors are covered with synthetic material, the relative humidity should be at least 30%.
Electrical fast transient/burst IEC 61000-4-4	+/- 2 kV for power supply lines +/- 1 kV for input/output lines	+/- 2 kV for power supply lines +/- 1 kV for input/output lines	Mains power quality should be that of a typical commercial or hospital environment.
Surge IEC 61000-4-5	+/- 1 kV line(s) to line(s) +/- 2 kV line(s) to earth	+/- 1 kV line(s) to line(s) +/- 2 kV line(s) to earth	Mains power quality should be that of a typical commercial or hospital environment.
Voltage dips, short interruptions, and voltage variations on power supply input lines IEC 61000-4-11	< 5% U_T (> 95% dip in U_T) for 0.5 cycles 40% U_T (60% dip in U_T) for 5 cycles 70% U_T (30% dip in U_T) for 25 cycles < 5% U_T (> 95% dip in U_T) for 5 sec	< 5% U_T (> 95% dip in U_T) for 0.5 cycles 40% U_T (60% dip in U_T) for 5 cycles 70% U_T (30% dip in U_T) for 25 cycles < 5% U_T (> 95% dip in U_T) for 5 sec	Mains power quality should be that of a typical commercial or hospital environment. If the user of the ZOLL ventilators requires continued operation during power mains interruptions, it is recommended that the ventilator be powered from an uninterruptible power supply or a battery.

SPECIFICATIONS

Power frequency (50/60) magnetic field IEC 6100-4-8	3 A/m	3 A/m	Power frequency magnetic fields should be at levels characteristic of a typical location at a typical commercial or hospital environment. For devices labeled for MR environments, follow the specific directions that ZOLL provides.
Note: U_T is the AC mains voltage prior to application of the test level			

Immunity Test	Test level	Compliance level	Electromagnetic environment-guidance
			Portable and mobile RF communications equipment should be used no closer to any part of the ZOLL ventilator, including cables, than the recommended separation distance calculated from the equation applicable to the frequency of the transmitter. Recommended separation distance
Conducted RF IEC 61000-4-6	3 Vrms 150 kHz to 80 MHz outside ISM bands ^a	3 V	$d = 1.17 \sqrt{P}$
	10 Vrms 150 kHz to 80MHz outside ISM bands ^a	10 V	$d = 1.12 \sqrt{P}$
Radiated RF IEC 61000-4-3	10 V/m 80 MHz to 2.5 GHz	20 V/m	$d = 0.6 \sqrt{P}$ 80 MHz to 800 MHz $d = 1.15 \sqrt{P}$ 800 MHz to 2.5 MHz Where P is the maximum output power rating of the transmitter in watts (W) according to the transmitter manufacturer and d is the recommended separation distance in meters (m). ^b Field strengths from fixed RF transmitters, as determined by an electromagnetic site survey ^c , should be less than the compliance level in each frequency range. ^d Interference may occurring the vicinity of equipment marked with the following symbol:
<p>Note 1: At 80 MHz and 800 MHz, the higher frequency range applies.</p> <p>Note 2: These guidelines may not apply in all situations. Electromagnetic propagation is affected by absorption and reflection from structures, objects, and people.</p>			



- a. The ISM (industrial, scientific, and medical) bands between 150 kHz and 80 MHz are 6.765 MHz to 6.795 MHz; 13.553 MHz to 13.567 MHz; 26.957 MHz to 27.283 MHz; and 40.66 MHz to 40.70 MHz.
- b. The compliance levels in the ISM frequency bands between 150 kHz and 80 MHz and in the frequency range 80 MHz to 2.5 GHz are intended to decrease the likelihood that mobile/portable communications equipment could cause interference if it is inadvertently brought into patient areas. For this reason, an additional factor of 10/3 has been incorporated into the formula used in calculating the recommended separation distance for transmitters in these frequency ranges.

- c. Field strengths from fixed transmitters, such as base stations for radio (cellular/cordless) telephones and land mobile radios, amateur radio, AM and FM radio broadcast, and TV broadcast cannot be predicted theoretically with accuracy. To assess the electromagnetic environment due to fixed RF transmitters, an electromagnetic site survey should be considered. If the measured field strength in the location in which the ventilator is used exceeds the applicable RF compliance level above, the ventilator should be observed to verify normal operation. If abnormal performance is observed, additional measures may be necessary, such as reorienting or relocating the ventilator.
- d. Over the frequency range 150 kHz to 80 MHz, field strength should be less than 3 V/m.

Recommended separation distances between portable and mobile RF communications equipment and the ZOLL ventilators. The device is intended for use in an electromagnetic environment in which radiated RF disturbances are controlled. You can help prevent electromagnetic interference by maintaining a minimum distance between portable and mobile RF communication equipment (transmitters) and the ventilators as recommended below, according to the maximum output power of the communication equipment.

Rated maximum output power of transmitter (W)	Separation distance according to frequency of transmitter (m)			
	150 kHz to 80 MHz outside ISM bands $d = 1.17 \sqrt{P}$	150 kHz to 80 MHz in ISM bands $d = 1.12 \sqrt{P}$	80 MHz to 800 MHz $d = 0.6 \sqrt{P}$	800 MHz to 2.5 GHz $d = 1.15 \sqrt{P}$
0.01	0.117	0.12	0.06	0.115
0.1	0.37	0.38	0.19	0.36
1	1.17	1.2	0.6	1.15
10	3.7	3.8	1.9	3.6
100	11.7	12	6	11.5

For transmitters rated at a maximum output power not listed above, the recommended separation distance d in meters (m) can be determined using the equation applicable to the frequency of the transmitter, where P is the maximum output power rating of the transmitter in watts (W) according to the transmitter manufacturer.

Note 1: At 80 MHz and 800 MHz, the separation distance for the higher frequency applies.

Note 2: The ISM (industrial, scientific, and medical) bands between 150 kHz and 80 MHz are 6.765 MHz to 6.795 MHz; 13.553 MHz to 13.567 MHz; 26.957 MHz to 27.283 MHz; and 40.66 MHz to 40.70 MHz.

Note 3: An additional factor of 10/3 has been incorporated into the formula used in calculating the recommended separation distance for transmitters in the ISM frequency bands between 150 kHz and 80 MHz and in the frequency range of 80 MHz to 2.5 GHz to decrease the likelihood that mobile/portable communications equipment could cause interference if it is inadvertently brought into patient areas.

Note 4: These guidelines may not apply in all situations. Electromagnetic propagation is affected by absorption and reflection from structures, objects, and people.

Appendix B

Accessories

The following accessories are available for use with the ZOLL Ventilator. To order any of these items, contact ZOLL or your local distributor.

Part Number	Part Description
024-0012-00	AC/DC Power Supply, 100-240 VAC, 100 W, 24 V, 4.2 A, IEC 320 Plug
708-0042-00	AC Power line cord, 6' (United States Version)
703-0731-01	Battery Pack, 6.6 Ah, 14.8 V, Lithium-Ion, 4S3P
710-0731-01	AC/DC Power Supply and Line Cord with NEMA 5-15P termination
704-0EMV-XX	Extension Cord 8' US Hospital Grade Female Plug to Country-Specific Connector (Contact factory for complete part number for each country)
708-0041-XX	Cordset, 6', IEC 60320-C5 Plug to Country-Specific Connector (Contact factory for complete part number for each country)
402-0032-00	Padded Carry Case, Tan, for Ventilator and Accessories
465-0024-00	Filter, Bacterial/Viral (B/V)
465-0025-00	Filter, HME/B/V, Heat and Moisture Exchanger
465-0027-01	Filter, Disk, B/V, Emergency Air Intake (replaceable part/service item)
465-0028-01	Removable foam compressor inlet filter (replaceable part/service item)
820-0108-00	Heat and Moisture Exchanger/Bacterial and Viral Filter (HMF), Adult, Deadspace \leq 75ml
820-0108-25	Heat and Moisture Exchanger/Bacterial and Viral Filter (HMF), Adult, Deadspace \leq 75ml (Case of 25)
820-0109-00	Heat and Moisture Exchanger/Bacterial and Viral Filter (HMF), Pediatric, Deadspace \leq 25ml

ACCESSORIES

Part Number	Part Description
820-0109-25	Heat and Moisture Exchanger/Bacterial and Viral Filter (HMF), Pediatric, Deadspace ≤ 25ml (Case of 25)
820-0110-00	Heat and Moisture Exchanger/Bacterial and Viral Filter (HMF), Infant, Deadspace ≤ 10ml
820-0110-25	Heat and Moisture Exchanger/Bacterial and Viral Filter (HMF), Infant, Deadspace ≤ 10ml (Case of 25)
820-0111-00	Adaptor, Metered Dose Inhaler, Adult
820-0111-25	Adaptor, Metered Dose Inhaler, Adult (Case of 25)
820-0112-00	Adaptor, Metered Dose Inhaler, Pediatric/Infant
820-0112-25	Adaptor, Metered Dose Inhaler, Pediatric/Infant (Case of 25)
704-0004-00	3 Liter O ₂ Reservoir Kit
704-0EMV-05	DC Power Cable, 28 VDC, Military Vehicle
704-0EMV-06	DC Power Cable, 12 VDC, Ambulance
708-0036-00	Cable, 3ft, Masimo SET Oximeter, LNCS Type DC-1, Adult Digit Sensor to DB9 Male Note: All LNCS Masimo cables are approved for use with the ZOLL ventilators
708-0037-00	Cable, 4ft, Masimo LNCS Patient Cable Type LNC-4, DB9 Female to Male Note: All LNCS Masimo cables are approved for use with the ZOLL ventilators
708-0039-00	Cable, 3ft, Masimo Adult Ear Sensor, LNCS Type DC-1, Adult Sensor to DB9 Male Note: All LNCS Masimo cables are approved for use with the ZOLL ventilators
708-0046-00	Cable, 6ft, BS 546 (UK-SA) Plug Right Angle
708-0047-00	Cable, 3ft, Masimo SET Oximeter, LNCS Type Inf/Inf-3, Infant Sensor to DB9 Male
708-0052-00	Cable, 3ft, Pulse Oximeter, Reusable, Finger Sensor, Pediatric
708-0053-00	Cable, 18", Pulse Oximeter, Disposable, Finger Sensor, Adult
708-0054-00	Cable, 18", Pulse Oximeter, Disposable, Finger Sensor, Pediatric
708-0056-00	Cable, 3ft, Masimo SET Oximeter, LNCS Type DC-1, Adult Digit Sensor to DB9 Male, Single Patient Note: All LNCS Masimo cables are approved for use with the ZOLL ventilators
708-0057-00	Cable, 3ft, Masimo SET Oximeter, LNCS Type DC-1, Pediatric Digit Sensor to DB9 Male, Single Patient Note: All LNCS Masimo cables are approved for use with the ZOLL ventilators
708-0063-00	Extension Cord Assembly, AS 3112 (Australian) Plug to US Hospital Grade Plug
708-0064-00	Cable, 6ft, Continental Europe CEE 7/7 to IEC-60320-C5 2.5 Amp Connector
820-0106-00	Circuit, 6 ft, Vent, Single Limb, Pediatric/Adult (disposable)
820-0106-15	Circuit, 6 ft, Vent, Single Limb, Pediatric/Adult (disposable) (Case of 15)
820-0107-00	Circuit, 6 ft, Vent, Single Limb, Infant/Pediatric (disposable)
820-0107-20	Circuit, 6 ft, Vent, Single Limb, Infant/Pediatric (disposable) (Case of 20)

Part Number	Part Description
820-0130-00	Circuit, 12 ft, Vent, Single Limb, Pediatric/Adult (disposable)
820-0130-10	Circuit, 12 ft, Vent, Single Limb, Pediatric/Adult (disposable) (Case of 10)
820-0131-00	Circuit, 12 ft, Vent, Single Limb, Infant/Pediatric (disposable)
820-0131-10	Circuit, 12 ft, Vent, Single Limb, Infant/Pediatric (disposable) (Case of 10)
825-0002-00	High pressure Oxygen Hose, DISS x DISS, oxygen, 6'
907-0731-03	Quick Reference Guide, laminated, Model 731 (non-MRI)
907-0731-04	Quick Reference Guide, laminated, Model 731 (MRI)
907-0731-05	Tag, Laminated, MRI Cautions/Warnings
906-0731-01	Operator's Guide (Commercial), Model 731
909-0731-01	CD format Operator's Guide (Commercial), Model 731
906-0731-03	Operator's Guide (Military), Model 731
909-0731-02	CD format Operator's Guide (Military), Model 731
906-0731-06	Operator's Guide (Commercial, Spanish), Model 731
909-0731-06	CD format Operator's Guide (Commercial, Spanish), Model 731
906-0731-07	Operator's Guide (Commercial, Portuguese), Model 731
909-0731-07	CD format Operator's Guide (Commercial, Portuguese), Model 731
906-0731-08	Operator's Guide (Commercial, Polish), Model 731
909-0731-09	CD format Operator's Guide (Commercial, Polish), Model 731
816-0731-00	Non-MRI Rolling Cart
816-0731-01	MRI conditional Rolling Cart
704-0731-09	IV support arm for Rolling Cart (aluminum, MRI safe)
820-0124-00	Breathing Circuit support arm for Rolling Cart (ferrous, not for MRI use)
800-0904-01	CCLAW (Critical Care Litter Attachment Widget) Mounting Bracket
703-0731-03	Carry-all Case with Foam Inserts, without AC Receptacle
703-0EMV-03	Carry-all Case with AC Receptacle
703-0731-11	Case, Transit Carry
703-0731-12	Case, Transit Carry, with AC Bulkhead Connector
703-0731-13	Case, Transit Carry, with AC Bulkhead & USB Connectors
703-0731-14	Case, Transit Carry, with Wheels & Pull-Out Handle
703-0731-15	Case, Transit Carry, with Wheels & Pull-Out Handle, AC Bulkhead Connector
704-0700-01	Check Valve Kit
812-0011-00	Mask, CPAP, #6, Large Adult
812-0011-20	Mask, CPAP, #6, Large Adult (Case of 20)

ACCESSORIES

Part Number	Part Description
812-0010-00	Mask, CPAP, #5, Adult
812-0010-20	Mask, CPAP, #5, Adult (Case of 20)
812-0009-00	Mask, CPAP, #4, Child
812-0009-20	Mask, CPAP, #4, Child (Case of 20)
812-0008-00	Mask, CPAP, #3, Small Child
812-0008-20	Mask, CPAP, #3, Small Child (Case of 20)
812-0008-40	Mask, CPAP, #3, Small Child (Case of 40)
812-0007-00	Mask, CPAP, #2, Infant
812-0007-20	Mask, CPAP, #2, Infant (Case of 20)
812-0007-40	Mask, CPAP, #2, Infant (Case of 40)
812-0006-00	Mask, CPAP, #1, Small Infant
712-0004-00	Mask, CPAP, #4, Child with harness
712-0004-20	Mask, CPAP, #4, Child with Harness (Case of 20)
712-0004-50	Mask, CPAP, #4, Child with Harness (Case of 50)
712-0002-00	Mask, CPAP, #5, Adult with Harness
712-0002-20	Mask, CPAP, #5, Adult with Harness (Case of 20)
712-0002-50	Mask, CPAP, #5, Adult with Harness (Case of 50)
712-0003-00	Mask, CPAP, #6, Large Adult with Harness
712-0003-20	Mask, CPAP, #6, Large Adult with Harness (Case of 20)
712-0003-50	Mask, CPAP, #6, Large Adult with Harness (Case of 50)
334-0125-00	Harness, Mask, Universal
334-0125-10	Harness, Mask, Universal (Case of 10)
820-0132-00	600 ml ZOLL Test Lung, plastic/silicone

Appendix C

Pulse Oximeter Principles

The Masimo SET[®] MS board pulse oximeter is based on three principles:

1. Oxyhemoglobin and deoxyhemoglobin differ in their absorption of red and infrared light (spectrophotometer).
2. The volume of arterial blood in tissue and the light absorbed by the blood changes during the pulse (plethysmography).
3. Arterio-venous shunting is highly variable and that fluctuating absorbance by venous blood is a major component of noise during the pulse.

The Masimo SET MS board pulse oximeter as well as traditional pulse oximetry determines SpO₂ by passing red and infrared light into a capillary bed and measuring changes in light absorption during the pulsatile cycle. Red and infrared light-emitting diodes (LEDs) in oximetry sensors serve as the light sources, a photodiode serves as the photodetector.

Traditional pulse oximetry assumes that all pulsations in the light absorbance are caused by oscillations in the arterial blood volume. This assumes that the blood flow in the region of the sensor passes entirely through the capillary bed rather than through any arterio-venous shunts. The traditional pulse oximeter calculates the ratio of pulsatile absorbance (AC) to the mean absorbance (DC) at each of two wavelengths, 660 nm and 905 nm:

$$S(660) = AC(660)/DC(660)$$

$$S(905) = AC(905)/DC(905)$$

The oximeter then calculates the ratio of these two arterial pulse-added absorbance signals:

$$R = S(660)/S(905)$$

This value of R is used to find the saturation SpO₂ in a look-up table built into the oximeter's software. The values in the look-up table are based upon human blood studies against a laboratory co-oximeter on healthy adult volunteers in induced hypoxia studies.

The Masimo SET MS board pulse oximeter assumes that arterio-venous shunting is highly variable and that fluctuating absorbance by venous blood is the major component of noise during the pulse. The MS board decomposes S(660) and S(905) into an arterial signal plus a noise component and calculates the ratio of the arterial signals without the noise:

$$S(660) = S1 + N1$$

$$S(905) = S2 + N2$$

$$R = S1/S2$$

Again, R is the ratio of two arterial pulse-added absorbance signals and its value is used to find the saturation SpO₂ in an empirically derived equation into the oximeter's software. The values in the empirically derived equation are based upon human blood studies against a laboratory co-oximeter on healthy adult volunteers in induced hypoxia studies.

The above equations are combined and a noise reference (N') is determined:

$$N' = S(660) - S(905) \times R$$

If there is no noise, N' = 0; then S(660) = S(905) x R, which is the same relationship for traditional pulse oximeter.

The equation for the noise reference is based on the value of R, the value being sought to determine the SpO₂. The MS board software sweeps through possible values of R that correspond to SpO₂ values between 1% and 100% and generates an N' value for each of these R-values. The S(660) and S(905) signals are processed with each possible N' noise reference through an adaptive correlation canceler (ACC), which yields an output power for each possible value of R (i.e., each possible SpO₂ from 1% to 100%). The result is a Discrete Saturation Transform (DST™) plot of relative output power versus possible SpO₂ value as shown in the following figure where R corresponds to SpO₂ = 97%:

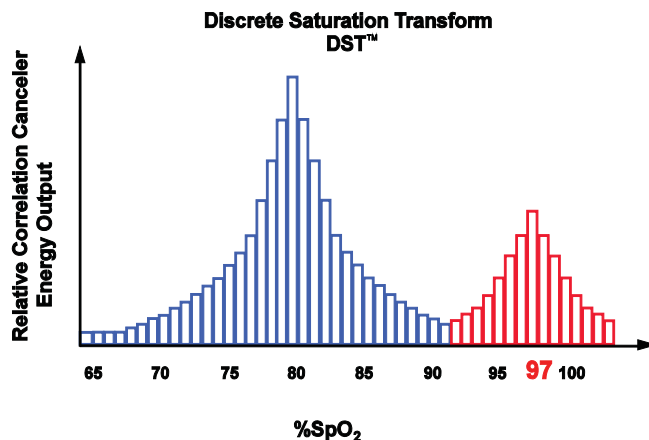

Pulse Oximeter Discrete Saturation Transformation

The DST plot has two peaks: the peak corresponding to the higher saturation is selected as the SpO₂ value. This entire sequence is repeated once every two seconds on the most recent four seconds of raw data. The MS board SpO₂ therefore corresponds to a running average of arterial hemoglobin that is updated every two seconds.

Appendix D

Patient Circuits

This appendix describes the ZOLL Ventilator's Patient Circuits. Specifically, this appendix provides the following information about patient circuits:

- Intended Use
- Specifications
- Directions for use
- Troubleshooting procedures

Pediatric/Adult, Single-Limb, Wye Patient Circuits

ZOLL provides the following pediatric/adult patient circuits for use with all models of the ZOLL defibrillator:

- Pediatric/Adult, 6 ft (REF 820-0106-XX)
- Pediatric/Adult, 12 ft (REF 820-0130-XX)

Intended Use -- Pediatric/Adult Patient Circuits

The ZOLL Pediatric/Adult, Single-Limb, Wye Patient Circuits (6 and 12 ft.) are intended for use with all models of the ZOLL Ventilator. ZOLL Ventilators have a single-limb circuit interface and no internal exhalation valve. Patient circuits are used as a means by which to transfer breathing gases from a ventilator to a patient (inhalation) and from a patient to atmosphere (exhalation).

The pediatric/adult patient circuits are intended for use when delivering tidal volume from 200 ml to Adult.

Specifications

Pediatric/Adult, 6 ft Patient Circuit

The Pediatric/Adult, 6 ft patient circuit (REF 820-0106-XX) has the following specifications:

- Internal Diameter: 22 mm
- R_{INSP} @ 30 Lpm: 0.02 hPa/l/min
- R_{EXP} @ 30 Lpm: 0.10 hPa/l/min
- C_T @ 60 hPa: 2.8 ml/hPa
- Deadspace: 22 ml
- Maximum Working Pressure: 100 hPa (cm H₂O)

Complies with ISO 5367. Breathing Tube intended for use with Anesthetic Apparatus and Ventilators.



Non-Sterile - For Single Patient Use Only



Not intended for use with heated humidification.



-40°C to 70°C (-40°F to 158°F)



Caution

During use circuit may come into contact with biohazard material. Handle carefully to avoid cross-contamination.

Contents of Pediatric/Adult, 6 ft patient circuit package:

- 72" (1.83 m) Ventilator Wye Breathing Circuit, with cut-to-size tube and exhalation valve
- Exhalation drive line (Clear) with connector
- Pressure line (Green) with connector

Pediatric/Adult, 12 ft Patient Circuit

The Pediatric/Adult, 6 ft patient circuit (REF 820-0106-XX) has the following specifications:

- Internal Diameter: 22 mm
- R_{INSP} @ 30 Lpm: 0.02 hPa/l/min
- R_{EXP} @ 30 Lpm: 0.10 hPa/l/min
- C_T @ 60 hPa: 2.8 ml/hPa
- Deadspace: 22 ml
- Maximum Working Pressure: 100 hPa (cm H₂O)

Complies with ISO 5367. Breathing Tube intended for use with Anesthetic Apparatus and Ventilators.



Non-Sterile - For Single Patient Use Only



Not intended for use with heated humidification.



-40°C to 70°C (-40°F to 158°F)



Caution

During use circuit may come into contact with biohazard material. Handle carefully to avoid cross-contamination.

Contents of Pediatric/Adult, 6 ft patient circuit package:

- 144" (3.65 m) Ventilator Wye Breathing Circuit, with cut-to-size tube and exhalation valve
- Exhalation drive line (Clear) with connector
- Pressure line (Green) with connector

Warning!

Compressible volume can significantly decrease the delivered minute ventilation of small adults and pediatric patients. When managing patients at risk, always correct for compressible volume following Step 6 in the following "Directions for Use" section of this appendix.

Warning!

Do not use this circuit with PEEP settings below 5 cm H₂O.

Warning!

Given the additional length of the 12ft circuit, the system may not be able to trap PEEP in patients with short expiratory time. Always ensure that the device is performing as required.

Directions for Use -- Pediatric/Adult Patient Circuits

The following steps describe how to attach a Pediatric/Adult patient circuit to a ZOLL Ventilator and verify that it is working correctly.

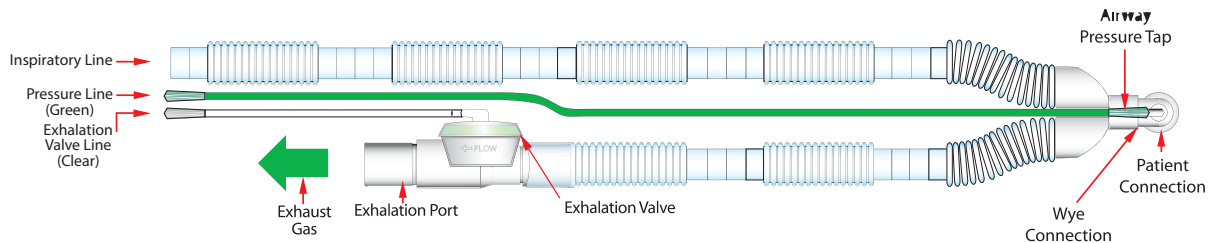
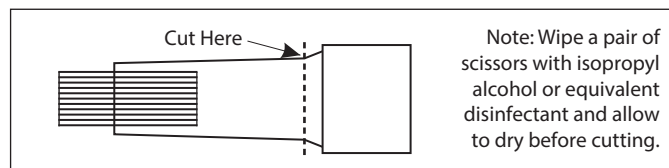

Figure D-1 Pediatric/Adult Patient Circuit

1. Connect inspiratory line to the ventilator's gas outlet.
2. Connect the opposite end of the green pressure line to the airway pressure transducer fitting on the ventilator. Make sure that the connection is secure by fully pushing the connector to the metal panel.
3. Connect the opposite end of the clear exhalation valve line to the exhalation valve fitting on the ventilator.

Cut off the cuff connector on the green pressure line as shown in the following figure, and connect securely to the transducer fitting:



4. Verify that all tubing and hose connections are securely tight.
5. Cycle the ventilator in accordance with operating instructions with the ventilator connected to a test lung prior to patient use; check for leaks and occlusions. Ensure that gas properly flows through the exhalation valve.
6. Use the following procedure to calculate compressible volume loss for the patient circuit:
 - a) Determine the tubing compliance (C_T):

$$C_T = \frac{\Delta V}{\Delta P} = \frac{\text{Volume Increase}}{\text{PIP (Peak Inspiratory Pressure)}}$$

I) Set the ventilator to the following:

Mode: AC (v)

BPM: 6, with low BPM limit set to 2

Tidal Volume: 100 ml

High Pressure Limit: 100 cm H₂O

PEEP: 0

II) Occlude the Y-connection at the patient end of the circuit with a gloved hand and initiate a mechanical breath with the circuit connected to the ventilator.

III) Record the volume (ml) and PIP (cm H₂O).

IV) Divide the volume (100 ml) by the PIP to obtain the tubing compliance:

$$C_T = 100 \text{ ml/PIP (Typical } C_T = 1.6 \text{ ml/cm H}_2\text{O at 25 degrees C.)}$$

Determine the compressible volume for a given breath (V_C).

$$V_C = C_T \times (\text{PIP} - \text{PEEP})$$

Add the compressible volume to the set tidal volume to compensate for the gas volume loss in the tubing.

Note: ZOLL Medical Corporation recommends that, on a daily basis, you examine the patient circuit for damage or wear, such as cracking, discoloration, or disfigurement. If there is any sign of physical degradation or if the unit is indicating breathing problems, replace the patient circuit.

Troubleshooting -- Pediatric/Adult Patient Circuits

If there are circuit-related alarms during trigger set up or initial use, such as Disconnect, PEEP Leak, Low Airway Pressure, or Incomplete Exhalation, check all circuit connections and the exhalation valve.

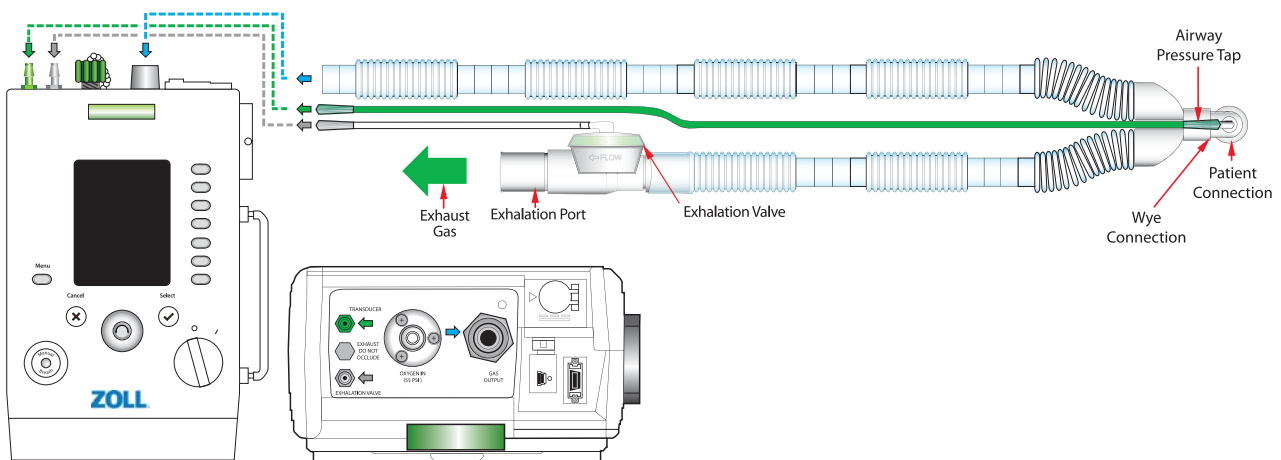

Figure D-2 Pediatric/Adult Patient Circuit Connections

If the exhalation valve is not performing, manually ventilate the patient and perform the following procedure:

1. Using a hemostat or a tongue blade, carefully open the exhalation valve as we show in the following illustration. Remove the top cover first, and then remove the silicon diaphragm. Place the silicon diaphragm in a clean area.

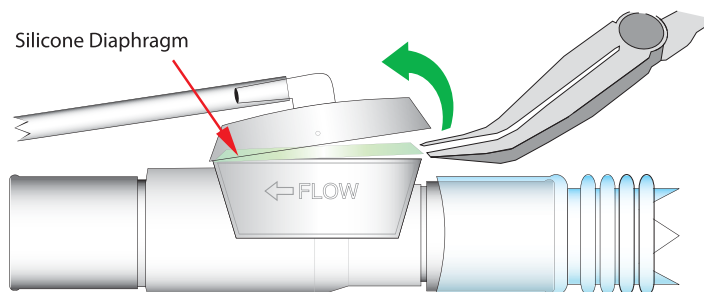

Figure D-3 Removing Silicon Diaphragm-- Pediatric/Adult Patient Circuit

2. Examine the silicon diaphragm for kinks, cuts, holes, or inconsistencies in the material.
 If the diaphragm is kinked, relax the silicone diaphragm with your fingers, ensuring that there are no longer any kinks (this usually takes a few seconds).
 If the diaphragm has a hole or cuts, replace the patient Circuit.

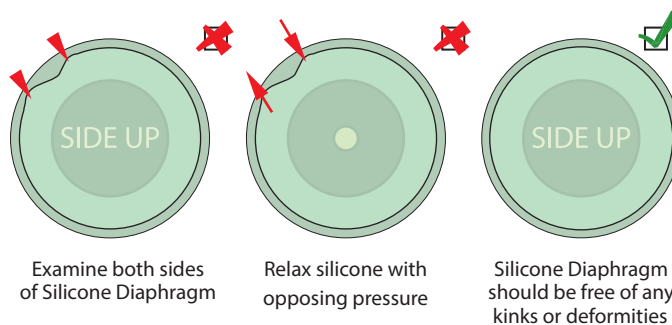

Figure D-4 Examining the Patient Circuit's Silicone Diaphragm

3. Carefully re-seat the silicone diaphragm in the exhalation valve seat. Tap around the silicone diaphragm lightly to ensure that kinks do not develop when closing the exhalation valve.
4. Locate the top of the exhalation valve, taking care not to touch the silicone diaphragm. Ensure that the barbed end with tubing is pointing into the FLOW direction. Apply enough pressure to *snap* the exhalation valve cover in place.

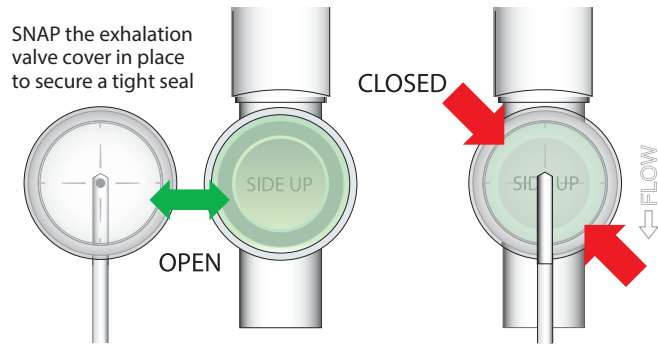

Figure D-5 Closing Exhalation Valve Cover

5. Test the patient circuit with a test lung before using it with a patient.

Infant/Pediatric, Single-Limb, Wye Patient Circuits

ZOLL provides the following infant/pediatric patient circuits for use with all models of the ZOLL defibrillator:

- Pediatric/Adult, 6 ft (REF 820-0107-XX)
- Pediatric/Adult, 12 ft (REF 820-0131-XX)

Intended Use

The ZOLL Infant/Pediatric, Single-Limb, Wye Patient Circuits (6 and 12 ft.) are intended for use with all models of the ZOLL Ventilator. ZOLL Ventilators have a single-limb circuit interface and no internal exhalation valve. Patient circuits are used as a means by which to transfer breathing gases from a ventilator to a patient (inhalation) and from a patient to atmosphere (exhalation).

This patient circuit is intended for use when delivering tidal volume from 50 ml to 300 ml.

Specifications

Infant/Pediatric, 6 ft Patient Circuit

The Infant/Pediatric, 6 ft patient circuit (REF 820-0107-XX) has the following specifications:

- Internal Diameter: 10 mm
- RINSP @ 15 Lpm: 0.11 hPa/l/min
- REXP @ 15 Lpm: 0.17 hPa/l/min
- C_T @ 60 hPa: 0.5 ml/hPa
- Deadspace: 4.2 ml
- Maximum Working Pressure: 100 hPa (cm H₂O)

Complies with ISO 5367. Breathing Tube intended for use with Anesthetic Apparatus and Ventilators.



Non-Sterile - For Single Patient Use Only



Not intended for use with heated humidification.



-40°C to 70°C (-40°F to 158°F)



Caution

During use circuit may come into contact with biohazard material. Handle carefully to avoid cross-contamination.

Contents of Infant/Pediatric, 6 ft patient circuit package:

- 72" (1.83 m) Ventilator Wye Breathing Circuit, with cut-to-size tube and exhalation valve
- Exhalation drive line (Clear) with connector
- Pressure line (Green) with connector

Infant/Pediatric, 12 ft Patient Circuit

The Infant/Pediatric, 12 ft patient circuit (REF 820-0131-XX) has the following specifications:

- Internal Diameter: 10 mm
- R_{INSP} @ 15 Lpm: 0.17 hPa/l/min*
- R_{EXP} @ 15 Lpm: 0.17 hPa/l/min
- C_T @ 60 hPa: 0.8 ml/hPa
- Deadspace: 4.2 ml
- Maximum Working Pressure: 100 hPa (cm H₂O)

* The extended length of the tubing in the 12 ft circuit results in a higher R_{INSP} compared to the 6 ft circuit.

Complies with ISO 5367. Breathing Tube intended for use with Anesthetic Apparatus and Ventilators.



Non-Sterile - For Single Patient Use Only



Not intended for use with heated humidification.



-40°C to 70°C (-40°F to 158°F)



Caution

During use circuit may come into contact with biohazard material. Handle carefully to avoid cross-contamination.

Contents of Infant/Pediatric, 12 ft patient circuit package:

- 144" (3.65 m) Ventilator Wye Breathing Circuit, with cut-to-size tube and exhalation valve
- Exhalation drive line (Clear) with connector
- Pressure line (Green) with connector

Warning!

Compressible volume can significantly decrease the delivered minute ventilation of small adults and pediatric patients. When managing patients at risk, always correct for compressible volume following Step 6 in the following "Directions for Use" section of this appendix.

Warning!

Do not use this circuit with PEEP settings below 5 cm H₂O.

Warning!

Given the additional length of the 12ft circuit, the system may not be able to trap PEEP in patients with short expiratory time. Always ensure that the device is performing as required.

Directions for Use -- Infant/Pediatric Patient Circuits

The following steps describe how to attach a Pediatric/Adult patient circuit to a ZOLL Ventilator and verify that it is working correctly.

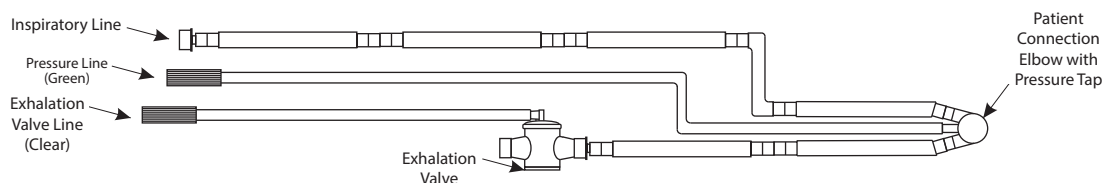
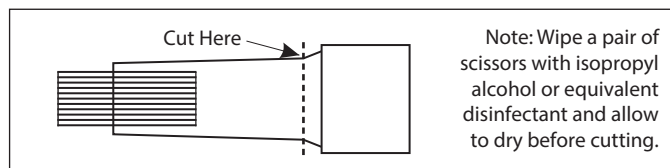

Figure D-6 Infant/Pediatric/ Patient Circuit

1. Connect inspiratory line to the ventilator's gas outlet.
2. Connect the opposite end of the green pressure line to the airway pressure transducer fitting on the ventilator. Make sure that the connection is secure by fully pushing the connector to the metal panel.
3. Connect the opposite end of the clear exhalation valve line to the exhalation valve fitting on the ventilator.

Cut off the cuff connector on the green pressure line as shown in the following figure, and connect securely to the transducer fitting:



4. Verify that all tubing and hose connections are securely tight.
5. Cycle the ventilator in accordance with operating instructions with the ventilator connected to a test lung prior to patient use; check for leaks and occlusions. Ensure that gas properly flows through the exhalation valve.

Note: ZOLL Medical Corporation recommends that, on a daily basis, you examine the patient circuit for damage or wear, such as cracking, discoloration, or disfigurement. If there is any sign of physical degradation or if the unit is indicating breathing problems, replace the patient circuit

Troubleshooting -- Infant/Pediatric Patient Circuits

If there are circuit-related alarms during trigger set up or initial use, such as Disconnect, PEEP Leak, Low Airway Pressure, or Incomplete Exhalation, check all circuit connections and the exhalation valve.

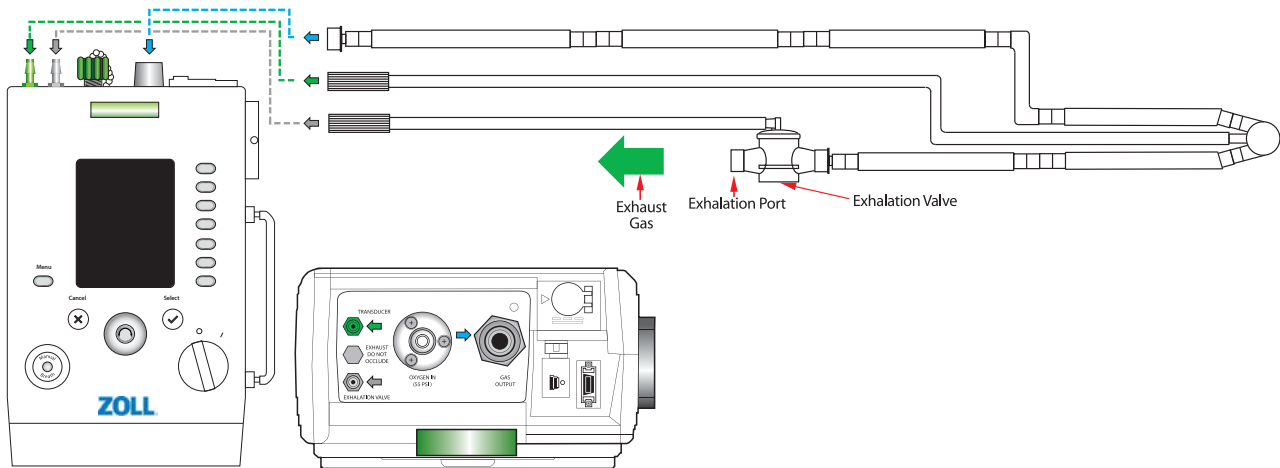

Figure D-7 Infant/Pediatric Patient Circuit Connections

If the exhalation valve is not performing, manually ventilate the patient and perform the following procedure:

1. Using a hemostat or a tongue blade, carefully open the exhalation valve as we show in the following illustration. Remove the top cover first, and then remove the silicon diaphragm. Place the silicon diaphragm in a clean area.

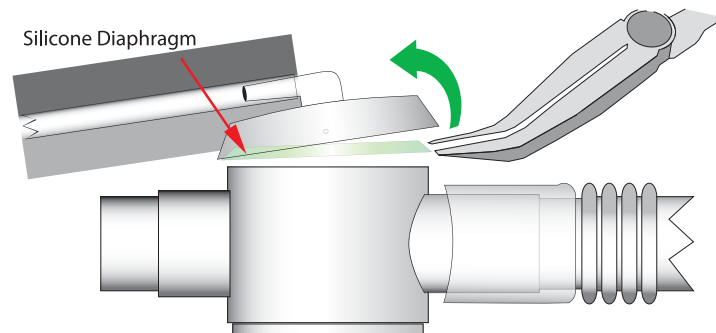

Figure D-8 Removing Silicone Diaphragm-- Infant/Pediatric Patient Circuit

2. Examine the silicon diaphragm for kinks, cuts, holes, or inconsistencies in the material.
If the diaphragm is kinked, relax the silicone diaphragm with your fingers, ensuring that there are no longer any kinks (this usually take a few seconds).
If the diaphragm has a hole or cuts, replace the patient Circuit.

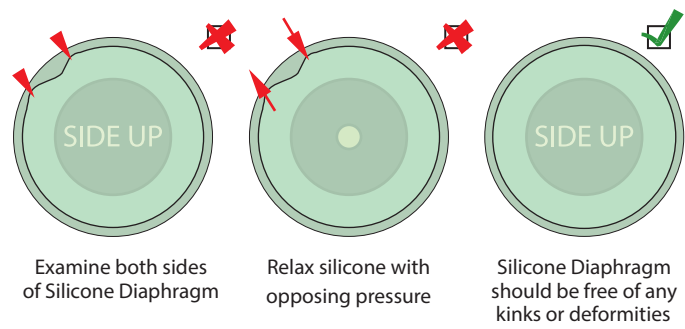

Figure D-9 Examining the Patient Circuit's Silicone Diaphragm

3. Carefully re-seat the silicone diaphragm in the exhalation valve seat. Tap around the silicone diaphragm lightly to ensure that kinks do not develop when closing the exhalation valve.
4. Locate the top of the exhalation valve, taking care not to touch the silicone diaphragm. Ensure that the barbed with tubing is pointing into the FLOW direction. Apply enough pressure to *snap* the exhalation valve cover in place.

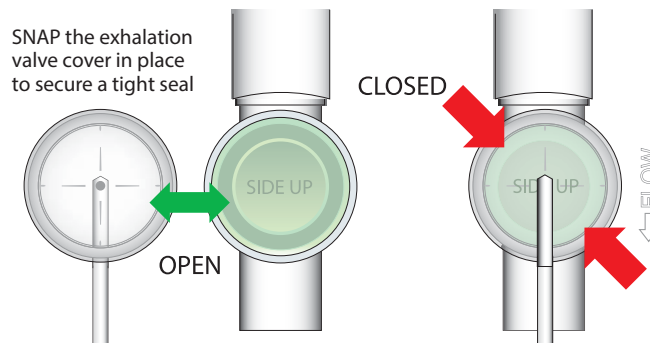

Figure D-10 Closing Exhalation Valve Cover

5. Test the patient circuit with a test lung before using it with a patient.